

Southwark Council

Camberwell Old Cemetery, &
Camberwell New Cemetery

Conservation Management Plan

Combined Appendices



Harrison

design – development

These Appendices are to be read as part of Conservation Management Plans for Camberwell Old Cemetery and Camberwell New Cemetery, produced for Southwark Council by Harrison Design Development.



Harrison

design – development

landscape design masterplanning landscape planning placemaking

Paul Harrison

Claire Halestrap

Andy Percival

Stuart Walker

With inputs from:



Alistair Henderson

Dunn&Co
Training and Consultancy Services

Ron Dunn

Catherine Bickmore Associates
ENVIRONMENTAL CONSULTANCY

Catherine Bickmore

THE UNIVERSITY *of York*

Julie Rugg

Appendix 2.1
Listings: Funerary Monuments, Sculptures, &
Architecture

SOUTHWARK

TQ3674NW
636-1/66/113

BRENCHLEY GARDENS
(South East side)
Crematorium, Camberwell New Cemetery

GV

II

Crematorium. 1939. Maurice Webb. Red brick plinth. Grey brick in Flemish bond and stone dressings. High pyramidal roof sheathed in copper to tower-cum-stack; hipped roof of green pantiles to chapel.

STYLE: Italian Renaissance manner, stylised and showing the influence of contemporary Scandinavian design.

PLAN: shallow, square chancel of one bay; nave of 2 bays, and narthex. Ancillary structures to ritual south-east. Loggia of 7 bays to ritual east. Offices and stack to north and north-west.

EXTERIOR: west elevation has 3 flat-arched entrances, the centre of which has a semicircular tympanum with low relief carving of the Holy Spirit. Elevation has a definite Brunelleschian air, divided into 3 bays by 4 giant pilasters of the Composite order, quarter pilasters to porch re-entrant corners. Tower square in plan with flush corner quoins, the whole recalling the tower of St Mark's in Venice.

Of particular note is the east elevation, with round-arched loggia between end bays, the rear wall bearing memorial plaques and pierced by round-arched openings leading to chapel and offices. Post WWII additions to the ritual north.

INTERIOR: plain walls, with high windows; coffered ceiling; moulded chancel arch springing from fluted piers. Seating and furnishings of an original design.

A subtle and handsome design which expresses the gravity of its purpose.

SOUTHWARK

TQ3574NE
636-1/63/115

BRENCHLEY GARDENS
(South West side)
Lodge, Camberwell New Cemetery

GV

II

Cemetery lodge. 1928-29. Designed by Sir Aston Webb, RA and his son, Maurice. Rubble masonry with stone dressings. Blue-green slate laid in diminishing courses. Single storey and attic. Round-arched loggia of 3 bays, now filled in by doorway and glazed wood screens. Each pier treated as a battered buttress; parapet with coping above; round-arched window to returns of loggia. The right return has a flat-arched, 2-light window with stone mullions and transoms stretching from ground floor into gable end. Single attic light above, also flat-arched. Rear extension for conveniences.

INTERIOR: not inspected.

Gothic in feeling, but with an attention to detailing, materials and workmanship that is more in keeping with an Arts and Crafts sensibility.

The Lodge is situated to north-east of cemetery gates and forms a group with the Gates, Waiting Room and Mortuary Chapels (qv).

SOUTHWARK

TQ3574NE
636-1/63/116

BRENCHLEY GARDENS
(South East side)
Mortuary Chapels, Camberwell New
Cemetery

GV

II

Anglican and nonconformist mortuary chapels. Dated 1928. Designed by Aston Webb and his son, Maurice; Messrs Galbraith Brothers, builders.

MATERIALS: coursed rubble masonry with dressed stone; hipped roof with flaring eaves of green slate laid in diminishing courses.

PLAN: 3-part composition with tower in the centre, the bottom pierced by a round-arched carriageway; to either side the chapels, that to left, or east, Anglican, that to right, Nonconformist.

EXTERIOR: carriageway set in gable facing, from which rises a tower with a square lower stage, having buttresses of 3 setbacks; pierced by double lancet light bell louvres; top stage is octagonal in plan, with clock face; corner buttresses from below continue above parapet to lower stage to form corner, flying buttresses; the whole tower tapers slightly. Above the carriageway, set in niche of the gable, is a freestanding sculpture.

Broad buttresses to either side of carriageway mark start of chapels proper, which have identical, mirror-image elevations: clerestory tucked below eaves of 6 windows set in stone band, all flat-arched. Gable facing cross wings at either end, each lit by a round-arched, 2 light, traceried window.

To return of each cross wing a single-storey, gable facing extension which serves as a narthex to the chapel naves; entrances via one round-arched door, sub-ordered, the boarded wood door of original design.

The rear elevations are identical to the fronts, except for single-storey vestries which flank the carriageway and have one round-arched entrance each; to side of each vestry entrance is a triple window with stone mullions. Gutters to eaves of original design, as are several rainwater heads.

INTERIOR: of former Anglican Chapel: furnishings intact, and include a reredos to tower wall; cross wings have quadripartite groin vaulting.

A stone plinth on the east return of the carriageway bears a commemorative inscription and dedication: Borough of Camberwell. This stone was laid by the Worshipful Mayor of Camberwell, Councillor HC Thompson, JP, on the 6th of October,

1928. Chairman Counc. W Brenchley, JP, Vice Chairman, Counc. CW Chessell. Aldermen, A Green, FJ Parce, HW Smyth, WFS Vicary, Councillors, JW Akam, GF Bushell, EH Davy, GE Deighton, AT Dyer MBE, C Galvin, JA Garner, WH Graham, JP, JW Lucas, E Miatt, GJ Maloney, JP, Elizabeth Morris, WO Bolger, AJ Percy, SAF Pulley, EG Watson, E Wray, Sir Aston Webb RA and Son, Architects, CE Newton, Town Clerk, Messrs Galbraith Bros, Ltd, Builders.

HISTORICAL NOTE: the cemetery opened in 1929, the result of 3 years planning. Initial estimates put the cost at £10,000. Webb was appointed architect by 11 January 1928.

Gothic in design, but with such a meticulous attention to detail, material, and workmanship as to belong, clearly and unmistakably, to an Arts and Crafts tradition.

Form a group with the Lodge and Waiting Room to the north, and the Entrance Gates from Brenchley Gardens (qqv).

SOUTHWARK

TQ3574NE
636-1/63/117

BRENCHLEY GARDENS
(South West side)
Waiting Room, Camberwell New
Cemetery

GV

II

Cemetery waiting room, now utility shed. 1928-29. By Aston Webb, and his son, Maurice. Rubble masonry with stone dressings. Blue-green slate laid in diminishing courses. EXTERIOR: one storey and single, 3-light, gable-facing attic dormer. One-window range to returns. 3-bay, round-arched loggia to ground floor, each pier treated as a battered buttress; returns of loggia pierced by a round-arched opening; moulded coping to low parapet above. Symmetrical-arched entrance set behind centre bay of loggia; boarded door of original design; to either side a 3-light, segmental-arched window with simply moulded mullions. One return a 2-light, flat-arched window rises from ground floor to attic. Single-storey, gabled extension to rear. All windows with moulded stone mullions. INTERIOR: not inspected. Gothic in feeling, but with an attention to detail, material and workmanship which betrays an Arts and Crafts sensibility. Forms a group with the Gates, Lodge and Mortuary Chapels (qqv).

SOUTHWARK

BROCKLEY WAY
Crematorium, Camberwell New Cemetery

See under: Crematorium, Camberwell New Cemetery BRENCHLEY GARDENS.

SOUTHWARK

TQ3574SW
636-1/64/345
27/09/72

FOREST HILL ROAD
(South West side)
Lodge to Camberwell Old Cemetery
(Formerly Listed as:
FOREST HILL ROAD
Lodge to Forest Hill Cemetery)

II

Lodge. 1856. Coursed rubble with ashlar dressings; gabled high-pitched slate roof above corbel table. Gothic style; L-shaped with entrance front on return from road. 2 storeys, 2 bays. Porch in angle has 4-centred arch under steep gable with 2 openings: the main one pointed with hood mould, the secondary one with Tudor arch. Windows with bar tracery of cusped lancets with pointed trefoils over. Right hand ground-floor window is a canted bay with stone-flagged roof. Another canted bay to left return (facing road). Diagonal buttresses to all outer corners. Empty with all openings blocked up at time of survey.
INTERIOR: not inspected.

SOUTHWARK

TQ3474SE
636-1/61/346
07/05/92

FOREST HILL ROAD
Monument to Charles Waters,
Camberwell Old Cemetery

GV

II

Monument. c1910. To Charles Waters. Marble group of a seated woman with a book/bible in lap embracing a small child on battered plinth.
Charles Waters (1839-1910) was the founder of the International Bible Reading Association of 1882 which numbered over 1 million members at the time of his death.
(Meller H: London Cemeteries: 95).

SOUTHWARK

TQ3474SE
636-1/61/347
07/05/92

FOREST HILL ROAD
Monument to James John Berkeley,
Camberwell Old Cemetery

GV

II

Chest tomb. c1865. Monument to James John Berkeley, civil engineer (1819-62). Stone chest tomb with vermiculated top and 3 steps. Above is a statue of a reclining female with an oval bust.

Inscription reads: "This monument is erected by the engineers and contractors of the Great Indian Peninsular Railway in token of their admiration of the distinguished professional career of their chief engineer James John Berkeley whilst engaged upon the extensive system of railways designed by him in Western India which comprised the BHOPE and THUL GHAT inclines up the SYHADRER range of mountains and in an affectionate remembrance of his high social qualities as well as of the uniform kindness and consideration with which he conducted his official duties".

James Berkeley, trained by Robert Stephenson, built the first railway line in India. £3,000 was raised by public subscription for this monument.

SOUTHWARK

TQ3474SE
636-1/61/348
07/05/92

FOREST HILL ROAD
Monument to Members of Public killed
by Zeppelin, Camberwell Old Cemetery

GV

II

Monument c1920. Stone weathered obelisk approx 3m high on 2 steps, inscribed on one side with the cross of Lorraine and surmounted with a cross of iron. The worn inscription gives the names of 21 civilians killed by bombing. There are large gold mosaic diamonds set around the inscription and the shaft is left roughly chiselled with smooth inscription stele emerging from it, surrounded by an oak and bay leaf garland.

SOUTHWARK

TQ3474SE
636-1/61/349
07/05/92

FOREST HILL ROAD
Monument to Rebekah Horniman,
Camberwell Old Cemetery

GV

II

Monument. c1895. To Rebekah, wife of FJ Horniman, tea merchant and founder of Horniman Museum. Tapering stone stele with moulded curved canopy with bronze tablet with figure of an angel.

(Meller H: London Cemeteries: 95).

Listed buildings within Southwark's operational cemeteries				
Name	Location	Listed	Description	At risk?
Entrance gates, piers and railings to Nunhead cemetery	Nunhead Cemetery	II	Entrance gates, gate piers and railings. C1840 by James Bunning.	No
East Lodge	Nunhead Cemetery	II	Cemetery lodge, C1840, by James Bunning for the London Cemetery Company. Situated adjacent to the main entrance gates in stock brick with stone roof. Built as a pair with the west lodge.	Yes -In ruinous condition, but stabilised.
West Lodge	Nunhead Cemetery	II	One of a pair of gate lodges, 1840, by James Bunning, for the London Cemetery Company.	No
Chapel	Nunhead Cemetery	II	Anglican cemetery chapel now deconsecrated. C1844 by Thomas Little. Rock faced stone with ashlar dressings.	No
Lodge to Camberwell Old Cemetery	Camberwell Old Cemetery	II	Cemetery lodge 1856. Coursed rubble with ashlar dressings	No
Crematorium	Camberwell New Cemetery	II	Maurice Webb 1939 in an Italian renaissance style	No
Gates, piers and railings to cemetery	Camberwell New Cemetery	II	Stone with railings and metal gates 1928-29.	No
Lodge (west side)	Camberwell New Cemetery	II	Former cemetery lodge (1928-29) designed by Sir Aston Webb in rubble masonry with stone dressings. Single storey with attic and distinctive round arched loggia of 3 bays.	Yes - Building is vacant and condition is deteriorating
Waiting room	Camberwell New Cemetery	II	Cemetery waiting room now utility building 1928-29 by Sir Aston Webb	No
Mortuary Chapels	Camberwell New Cemetery	II	Anglican and non-conformist mortuary chapels dated 1928 by Aton Webb. Coursed rubble masonry with dressed stone; hipped roof with flaring eaves in green slate laid in diminishing courses.	No

Listed funerary monuments within Southwark's operational cemeteries				
Name	Location	Listed	Description	At risk?
Monument to Henry Daniel	Nunhead Cemetery	II	C.1867. Stone monument. A heavily swathed vestal figure stands upon a garlanded base with cherubs heads set at the corners. This collection of motifs is in turn supported by plinth with inverted torches at the angles (repeating those on the entrance gate piers).	No
Monument to John Allen	Nunhead Cemetery	II	C.1865. Granite aedicule on 2-stage base, with 4 columns per side, surmounted by an arched roof with 2 lion masks per side and a ridge with 2 Celtic cross finials. Steps leading to vault in front. Marble relief of the Ascension on front, bronze portrait roundel on rear.	No
Monument to Maria Proom	Nunhead Cemetery	II	C.1872. Pink and grey granite, Carrara marble. A tall column upon a square plinth surmounted by a marble figure of a praying woman. Unusual in form and size, the monument is based upon Continental Catholic statues of the Virgin Mary.	Yes – Ground subsidence may cause serious disturbance.
Monument to Oppenheim and Schroeter	Nunhead Cemetery	II	C.1876. Portland stone with Carrara marble reliefs. A square plinth on a 2-stage base, with marble bas-reliefs on 3 sides and an inscription on the 4th, surmounted by a projecting entablature and a pedimented cover. The reliefs depict an angel beside a death-bed, an angel beside a female bust on a plinth which is fondled by a seated and blind mourning man, and a relief showing a woman with brushes and a palette.	No
Monument to Sophia Kempton	Nunhead Cemetery	II	C.1849. Portland stone. Battered chest tomb with acroteria at corners and relief of an urn beneath a weeping willow within the pediment on the front. Inscription panels recessed into the sides of the chest.	No
Monument to Thomas Humphreys	Nunhead Cemetery	II	c1868. To Thomas Humphreys, Pink and grey granite. Statue of Hope on top of a pink granite column with an anthemion-enriched capital.	No

Monument to Vincent Higgins	Nunhead Cemetery	II	C.1844. Portland Stone. Plain square stele set within canopy carried on 4 columns with lotus leaf capitals, surrounded with triangular pediments.	No
Stearns Mausoleum	Nunhead Cemetery	II	C.1900. Doulton's terracotta. Romanesque arched doorway set below crowstep gable; side walls with arcade of 3 Romanesque openings below an embattled parapet pierced with arched openings carried on squat colonnettes, above projecting water spouts. Lower parts of walls are battered outwards.	No
The Scottish Martyrs' Memorial	Nunhead Cemetery	II	1851. Granite. Obelisk, 10m high, on square base with inscription on each side, set within low rails of twisted iron carried by squat corner posts.	No
Monument to Charles Waters	Camberwell Old Cemetery	II	C.1910. Marble group of a seated woman with a book/bible in lap embracing a small child on battered plinth.	Yes - Ground subsidence may cause serious disturbance.
Monument to Members of Public killed by Zeppelin	Camberwell Old Cemetery	II	C.1920. Stone weathered obelisk approx 3m high on 2 steps, inscribed on one side with the cross of Lorraine and surmounted with a cross of iron. The worn inscription gives the names of 21 civilians killed by bombing. There are large gold mosaic diamonds set around the inscription and the shaft is left roughly chiselled with smooth inscription stele emerging from it, surrounded by an oak and bay leaf garland.	No
Monument to James John Berkeley	Camberwell Old Cemetery	II	c1865 Stone chest tomb with vermiculated top and 3 steps. Above is a statue of a reclining female with an oval bust.	Yes – Ground subsidence may cause disturbance.
Monument to Rebekah Horniman	Camberwell Old Cemetery	II	c1895. To Rebekah, wife of FJ Horniman, tea merchant and founder of Horniman Museum. Tapering stone stele with moulded curved canopy with bronze tablet with figure of an angel.	Yes – Bronze tablet is missing presumed stolen.

Appendix 2.2
Nature Conservation Assessment
(Catherine Bickmore Associates July 2011)

Southwark Council

Camberwell Old Cemetery,
Southwark:
Ecological assessment

December 2011

Catherine Bickmore Associates Ltd
ENVIRONMENTAL CONSULTANCY

LFG - 5, Lafone House,
11 - 13 Leathermarket Street,
London, SE1 3HN

Tel: 020 7357 6700
E-mail: info@bickmoreassociates.co.uk
Website: www.bickmoreassociates.co.uk

CONTENTS

SUMMARY	2
1 INTRODUCTION	3
2 SURVEY METHODS	4
3 DESK STUDY FINDINGS.....	5
4 FIELD SURVEY FINDINGS.....	9
5 RECOMMENDATIONS: CONSTRAINTS AND OPPORTUNITIES	14
REFERENCES.....	18
APPENDIX I: PHOTOSHEET – OLD CEMETERY	19
APPENDIX II: SPECIES LIST	22
APPENDIX III: SUMMARY OF LEGISLATION.....	25

Drawings

645/01 Camberwell Old Cemetery: Phase one habitat survey

SUMMARY

An ecological assessment was carried out in 2011 at Camberwell Old Cemetery, Southwark, in connection with plans to expand the burial capacity. A phase one habitat survey was undertaken and a general overview of habitats on the whole site is presented, with additional detail regarding Areas J to O, H in the northwest and F/F1 in the south where additional burial capacity is specifically being considered.

The cemetery is a Site of Borough Importance (Grade I) for nature conservation however its importance comes mostly from its location and extent as an area (11.8 ha) of semi natural open space within an otherwise built up residential area. The Cemetery site consisted of common and easily re-creatable habitats such as amenity grassland with areas of semi-improved grassland between graves. The extensive wooded/scrub area in the northern part of the cemetery was likely to support breeding birds and foraging and possibly roosting bats, hedgehog, stag beetle and sheltering amphibians/reptiles. Scattered trees and scrub belts around the site also provided local conservation interest and potential for breeding birds and pipistrelle bats the later recorded within the cemetery.

Potential areas for re use as additional burial are considered, in particular areas F and F1, and recommendations are given to minimise the impacts of expansion on features of nature conservation interest. Opportunities to enhance biodiversity within the Cemetery are also identified including production of a management plan.

1 INTRODUCTION

- 1.1 Catherine Bickmore Associates were commissioned on 18th July 2011 on behalf of The London Borough of Southwark to undertake a phase one ecological survey of Camberwell Old Cemetery, London, SE23 3RD. The aim of the survey was to determine constraints and opportunities with regards to nature conservation in connection with the development of a strategy to create additional space for burial within the cemetery grounds, and in addition to consider specific proposals for area F and F1.
- 1.2 The Old Cemetery (c.11.8ha) is located in a residential area in East Dulwich to the south of Peckham Rye Park, and to the west of Camberwell New Cemetery. The main entrance to the Old Cemetery is from Forest Hill Road (centred on grid reference TQ 349 742).

Outline

- 1.3 Survey methods including desk study data collection and field survey are outlined in Section 2, with desk study findings presented in Section 3, and field survey results described in Section 4 followed by an assessment of nature conservation interest. Constraints and opportunities including recommendations with regards to expanding burial area and improving nature conservation interest of the cemetery are given in Section 5. Appendices include a species list, photographs of the habitats on site, followed by a summary of relevant legislation.

2 SURVEY METHODS

Desk study

- 2.1 Biological records were obtained from the National Biological Network (NBN, 2011) and from Southwark Council who provided a species list for the cemetery and a description from the 1995 ecological survey of the cemetery as a site of borough importance (grade I). Magic Map and Natural England's Nature on the Map web pages were checked for site designations.
- 2.2 Further information regarding sites of nature conservation interest was obtained from the London Borough of Southwark Biodiversity Action Plan 2006-2010 and London Borough of Southwark (2011) and Lewisham Council (2011) local plans and proposal maps.

Field survey

- 2.3 A site visit was undertaken on 7th September 2011, a cloudy, mostly dry day, by a qualified ecologist. The field survey method followed phase one habitat survey procedures in Nature Conservancy Council (1990) and comprised a walk over of the site recording main habitat types and species present using the DAFOR¹ scale (Nature Conservancy Council, 1990).
- 2.4 Features of note were described and plotted on a plan along with the main habitat types (drawing 645/01). A broad description is given in the text of the habitats across the site, with a more detailed description of Areas J to O and H and F/F1 where cemetery re-use is planned. Common names are used throughout the text with scientific equivalents for flora listed in Appendix II, applying BSBI (2007), or Stace (2010) nomenclature.
- 2.5 The survey was subject to access and seasonal constraints reflecting the conditions on site at the time of the survey. September is too late to record vernal species however conditions were suitable for the purpose of the survey.

¹ D = dominant; A = abundant; LA = locally abundant; F = frequent; LF = locally frequent; O = occasional; R = rare

3 DESK STUDY FINDINGS

Site context and history

- 3.1 The Old Camberwell Cemetery covers c.11.8ha and is located c.400m to the west of Camberwell New Cemetery, with the main entrance located to the west of Forest Hill Road (drawing 645/01). The Cemetery is bounded by residential areas on all sides, with Brenchley Gardens SNCI providing a green linkage to the north east to One Tree Hill Site of Nature Conservation Importance (SNCI) and Local Nature Reserve (6.6ha) and Camberwell New Cemetery SNCI. Peckham Rye Park is located approximately 200m to the north of the Old Cemetery.
- 3.2 The cemetery itself forms part of a Site of Borough Importance and is also a Green Chain Park in the Southwark Core Strategy (Southwark Council, 2011), and is therefore protected as an important open space under Policy 11.
- 3.3 The majority of the site is relatively level ground that falls gradually from south to north with localised raised areas in the north west and north east.
- 3.4 Camberwell Old Cemetery was first used for burials in 1856 when it was surrounded by farmland bounded by roads approximately on their present alignment (1839 Tithe map and OS 1874 1st edition map). Since when, the entire cemetery has been intensively used for burials. Now however, the northern part of the cemetery has become wooded over, particularly in the north west, while the southern part is regularly used for burials.

Sites of nature conservation interest

- 3.5 Sites of Importance for Nature Conservation (SINC) are those sites which contain the best examples of habitats or rare species/assemblages of species or important populations of species or sites which are of particular significance in being in an otherwise heavily built up area. Sites of Metropolitan Importance are significant on a London-wide scale while Sites of Borough Importance are important from a borough perspective. Borough sites are divided into two categories, Grade I and Grade II, according to their quality, however all are important at a borough-wide scale.
- 3.6 Sites of nature conservation interest are protected under the London Plan (Greater London Authority, 2011) which states that sites should be given a level of protection commensurate with their importance and adverse impacts on the biodiversity interest should be avoided or minimised and mitigated/compensated.
- 3.7 The Old Cemetery is a Site of Borough Importance (Grade I) named Camberwell Old Cemetery, So.BI 8. The site covers approximately 11.6ha and includes valuable wildlife habitat in the north consisting of tall grassland and woodland (including black poplar trees) with dense undergrowth growing over the gravestones, resulting in a 'wild feel' which is valuable in such a built up area (London Ecology Unit, 1989). It is also designated as Metropolitan Open Land (OS149).
- 3.8 Within Southwark there are six Sites of Borough Importance within the vicinity of the Old Cemetery:

Brenchley Gardens (2.9ha) is a Grade 2 ecological site including woodland and grassland (Southwark Biodiversity Action Plan) immediately to the east of the Old Cemetery, to the east side of Forest Hill Road. It provides a green link to One Tree Hill and the New Cemetery.

To the east of Brenchley Gardens is Aquarius Golf Course Site of Borough Importance (Grade II) (2.4ha) consisting of neutral grassland over a covered reservoir.

One Tree Hill (6.8ha) which is Grade 1 ecological site and Local Nature Reserve with relict acid grassland and secondary woodland (London Ecology Unit, 1989) which is c. 300m to the north east of the Old Cemetery.

Camberwell New Cemetery, Honour Oak Crematorium and adjacent area (11ha) (So.BII 5) is on the eastern boundary of One Tree Hill. The key habitat/species of this Site of

Borough Importance (Grade II) are listed as secondary woodland, hedges, mature trees and common lizard (associated with the allotments), and the objective for the site is to manage the boundaries for wildlife (London Borough of Southwark, 2006-2010).

Peckham Rye Park and Common (45ha) is a Site of Borough Importance (Grade II) with conservation interest in the remnant of a stream system and bankside vegetation, several ponds and a small area of woodland. It is located c.200m to the north of the Old Cemetery.

Dawson's Hill (2.4ha) is a Site of Borough Importance (Grade II), c.200m to the west of the Old Cemetery, which includes neutral grassland slopes.

- 3.9 Forest Hill to New Cross Gate Railway Cutting Site of Metropolitan Importance lies approximately 0.8km to the south east of the Old Cemetery, in Lewisham. It is listed as containing 'probably the finest suite of rail side habitats in London', including woodland, scrub, acid and neutral grassland and reed beds (Lewisham Council, 2011).
- 3.10 Horniman Nature Trail is a Site of Borough Importance in Lewisham, consisting of a disused railway line with woodland, grassland and scrub, run as a nature trail by the Horniman Museum (GLC Ecology Handbook No. 4), c.100m to the south of the Old Cemetery.
- 3.11 There are no statutory internationally or nationally important sites for nature conservation within 5km of the cemetery.

Protected species

- 3.12 Records relating to protected species are mostly over 45 years old and may no longer be valid on account of the urban context. A record of common toad is present in the 10km grid square area covering the site, and a 1960 great crested newt record and 1949 record of slow worm was found on NBN (2011) from the grid square c.1km to the east of the cemetery. A 1965 record of hazel dormouse from West Norwood (c.3-5km to south west, exact location unspecified) was also obtained from NBN.
- 3.13 Bird records included a black redstart record from 2009 in Peckham Rye Park, c.200m to the north of the Old Cemetery, and a number of common garden birds. BAP species: hedgehog have been recorded in Dawson's Hill, c.200m to the west of the Old Cemetery, and stag beetle have been recorded within 1km to the south of the site in 2005.
- 3.14 A bat survey assessment of trees was carried out in Area E, F and H at Camberwell Old Cemetery in August 2011 (ASW Ecology, 2011). Of some 34 trees surveyed (those subject to works in winter) only 3 had potential for bat roosts, and there were no confirmed bat roosts reported. An emergence survey was carried out of the trees with potential for roosts in Areas F and H in September 2011, and no bat roosts were identified. A number of feeding and commuting common pipistrelle were recorded indicating that the cemetery provides foraging habitat for bats. It was also possible that other trees in the cemetery were used as roosts by bats (ASW Ecology, 2011).
- 3.15 Southwark Council's 1995 ecology survey of the cemetery noted the presence of an excellent selection of mature trees including several old oak pollards and a black poplar tree, a nationally scarce and declining tree. It described the cemetery as consisting mainly of grassland, scrub, mature trees and vegetated gravestones, including a substantial area of scrub and recently cleared woodland in the north west. It also listed the presence of species of conservation concern such as house sparrow, and the specked wood butterfly which is a flagship species under the local BAP woodland Habitat Action Plan (HAP), and the meadow brown butterfly, a flagship species under the parks and open spaces HAP (London Borough of Southwark, 2006-2010).
- 3.16 Species present within nature reserves with public access along the Forest Hill to New Cross Gate Railway Cutting Site included slow worm and common lizard, tawny owl, great and lesser spotted woodpecker and sparrow hawk. Common lizard has also been recorded in the allotments to the south of Camberwell New Cemetery (London Borough of Southwark, 2006-2010).

Biodiversity Action Plans

- 3.17 In 2010 the EU agreed to a vision and 2020 mission for biodiversity including protecting, valuing and restoring ecosystem services and biodiversity by 2050 and halting degradation/loss by 2020 (Defra, 2011). The European Commission (2011) have adopted a new EU biodiversity strategy to help meet this goal.
- 3.18 The UK Biodiversity Action Plan outlines the UK's strategic approach to biodiversity conservation which is based on the ecosystem approach along with priority species and habitat action plans (UK Biodiversity Partnership, 2007). It includes a number of potentially relevant habitat and species plans including for hedgerows, lowland mixed deciduous woodland and ponds, and species plans for stag beetle, dormouse, noctule and pipistrelle bats, Western European hedgehog and all reptile species, common toad, great crested newt, along with bird species dunnock, song thrush, common cuckoo, common starling, house and tree sparrow and lesser spotted woodpecker.
- 3.19 Following the overall goals of the EU biodiversity strategy, The England Biodiversity Action Plan sets out the country's overall strategy with regard to biodiversity which is based on an integrated large-scale/landscape approach to conservation with four main outcomes relating to habitats and ecosystem on land and in the sea, species protection and people engagement. The strategy's vision is stated as being:
- “to halt overall biodiversity loss, support healthy well-functioning ecosystems and establish coherent ecological networks, with more and better places for nature for the benefit of wildlife and people.”* (Defra, 2011).
- 3.20 The English Biodiversity Action Plan includes a number of priority actions, one of which is to bring a greater proportion of existing woodlands into sustainable management and to increase the area of woodland in England.
- 3.21 The London Biodiversity Partnership (2011) have developed 11 habitat action plans (HAP) including for woodland, standing water, reed beds, and parks and urban green spaces such as cemeteries, along with a list of other important habitats which have targets but no action plan such as built structures, and open landscapes with old trees. Targets to maintain, enhance and extend the habitats are given in the London Plan (Greater London Authority, 2011). There are species action plans for bats, reptiles, house sparrow and stag beetle; and a list of other important species including black redstart and common dormouse.
- 3.22 Within the London BAP Parks and Urban Green Spaces HAP is a specific action plan for churchyards and cemeteries. The aims of the action plan are:
- To develop a strategic approach to the protection, management and enhancement of the nature conservation value of cemeteries and churchyards.
- To respect the primary purpose of cemeteries and churchyards, which is that of burial and as a space to accommodate grieving visitors.
- To secure the involvement of all London's faiths and communities in the conservation of churchyards and cemeteries, by raising awareness.
- 3.23 Two advice notes regarding wildlife in churchyards and implementation of biodiversity action plans in churchyards and cemeteries is available on the Diocese of London (2011) website. The Diocese of London is also developing a project with the Diocese of Southwark, and they are progressing with fundraising to assess the habitats, fauna and flora in churchyards across the Dioceses of London and Southwark (Diocese of London, 2011).
- 3.24 The local London Borough of Southwark Biodiversity Action Plan 2006-2010 contains habitat action plans to enhance biodiversity in parks and open spaces (including sports fields but not cemeteries) and woodland (including secondary woodland, scrub with trees and hedgerows), and species action plans for bats and stag beetle.

- 3.25 Additional flagship species within the woodland habitat action plan included speckled wood butterfly on woodland edges and glades, oak species and associated purple hairstreak butterfly, greater spotted woodpecker and sparrow hawk.
- 3.26 Additional flagship species within the parks and open spaces habitat action plan included oxeye daisy, rosebay willow herb, buttercups, song thrush, greater spotted woodpecker, holly blue butterfly, meadow brown butterfly and six spot burnet moth.

4 FIELD SURVEY FINDINGS

Overview

- 4.1 The central part of the cemetery tends to be associated with historic burial areas with the surrounding area in use for 'commoners' with those in the northern part much over grown with trees and shrubs. The north western area has been subject to tipping and also has regenerated into woodland scrub with localised tall ruderal vegetation. Scattered trees amongst a mostly closely maintained grass sward with some open areas without trees was characteristic of the eastern area.
- 4.2 Roads formed the south eastern (Wood Vale) and western (Underhill Road) boundaries with boundary fences mostly associated with occasional mature trees and a narrow margin of bramble scrub. The majority of the north western and northern eastern boundaries were backed onto by gardens of adjacent residential properties in Ryedale, and Forest Hill Road, with the exception of a short section by main vehicle entrance off Forest Hill Road.

Habitat types

- 4.3 A number of habitat types can be distinguished within the cemetery (drawing 645/01) with the main habitat types described below:

Amenity grassland with areas of introduced ornamental planting of shrubs and scattered trees

Semi improved species poor grassland mostly with scattered trees

Tall ruderal

Secondary woodland/scrub

Scrub/tree lines

- 4.4 There was an inevitable gradation between the classifications of amenity, improved and poor semi-improved grassland. The grassland between all the graves appeared fairly regularly cut, however the degree of maintenance appeared to vary between areas resulting in two different grassland classifications: amenity grassland (closely maintained uniform, short grassland with low diversity of grass and few forbs), and poor semi-improved grassland (slightly higher species diversity, rougher grassland, less closely maintained). The semi-improved grassland areas tended to be associated with graveyards of older graves and those with kerb-set memorials which often supported additional species.

Amenity grassland with areas of introduced ornamental planting

- 4.5 Areas of improved or amenity grassland mainly related to the south eastern, southern, north eastern parts of the cemetery (areas W1-4, T, F, F1, H1, Q1) with a variable number of scattered trees. The grassland presented a mostly low, regularly cut sward in areas with memorial stones and recent burials including recent burial mounds (Photo P1) providing areas with bare cloddy clay.
- 4.6 Area Q1 and parts of area F and F1 provided rough cut grass with some more frequently mown paths and a scatter of mature and recently planted ornamental trees (Photo P2) with a few fallen trees as dead wood in area F (photo P3) (with the arisings being raked off Q1 at the time of the survey).
- 4.7 Rose beds were present near the entrance together with a section of garden privet and holly hedge, with some other rose beds in the central area. Occasional forbs were present including clover, creeping cinquefoil, daisy, ribwort plantain.
- 4.8 A small area along the eastern boundary of area E had been cleared leaving a distinctive trunk of a former pollarded plane tree (photo P4) alongside a cypress hedge.

Species poor semi-improved grassland

- 4.9 Species poor semi improved grassland was concentrated in the central part of the cemetery in association with the historic burials and over areas with uneven ground, partly shaded by scattered mature trees. These included parts with a high density of kerb stone graves (photo



KEY

-  Amenity grassland
-  Species-poor semi-improved grassland
-  Tall ruderal
-  Dense scrub
-  Scattered scrub
-  Introduced shrub
-  Broad-leaved semi-mature woodland
-  Scattered trees/tree-line
-  Species-poor hedge
-  Hardstanding
-  Burial Strategy areas

Ordnance Survey Licence No. AL100036425

Drawn by	DL	Check by	CB	Date	Oct 2011	Scale	See bar
----------	----	----------	----	------	----------	-------	---------

Camberwell Old Cemetery

Phase 1 habitat survey

Catherine Bickmore Associates Ltd
ENVIRONMENTAL CONSULTANCY

LFG 5 Lafone House, Leathermarket Street, London SE1 3HN
 Tel: 020 73576700
 E-mail: info@bickmoreassociates.co.uk
 Website: www.bickmoreassociates.co.uk

Drawing number
645/01

Scale bar
0m 50m 100m



Burial Strategy

P5) with other areas providing open grassland defined by a network of narrow mostly surfaced paths. Smaller areas of semi improved grassland were more extensively maintained as rough grassland. Species poor semi improved grassland also penetrated glades/rides within the wooded area in the northern part.

- 4.10 Within a mostly low maintained sward the grassland included a variable extent of species such as American willow herb, autumn hawkbit, common birds foot trefoil, common sorrel, black knapweed, creeping buttercup, creeping cinquefoil, creeping Jenny, field bind weed, greater plantain, hedge crainsbill, oxeye daisy, meadow vetchling, meadow buttercup, ragwort, red clover, ribwort plantain, self heal, thyme leaved speedwell, white clover, yarrow. Within the chippings of older kerb stone areas there was a variable cover of stone crops including tasteless, reflexed, and white (photo P6) with some kerb stone enclosures having been colonised by grassland including species such as oxeye daisy (photos P5 & P7). More rarely occurring species included common sedge, pendulous sedge, crow garlic, violet. Small stands of Japanese knotweed were recorded amongst kerb set graves in area X in the east.
- 4.11 Within the wooded areas (H, J, K, L, O1-3) the species poor semi improved grassland formed a variably narrow strip incorporating kerb set graves either side of the tarmac covered paths and mostly overhung by trees (photo P8 & P9). Some sections of the path had over grown with other areas as exposed tarmac or bare ground. Semi improved grassland was also present as gladed areas within the wooded cover. These areas appeared to be infrequently cut.
- 4.12 Along and either side of the paths, both within and interspersing kerb stone graves, species within the grassland included: American willow herb O, barren broome O, black medick O, cocksfoot O, common birdsfoot trefoil O, common vetch O, cow parsley O, cleavers O, creeping bent O, crow garlic R, creeping cinquefoil O, creeping Jenny F-LA, false oat grass F, germander speedwell O, Japanese knotweed LF, greater plantain F, hawkweed ox tongue O, hedge bindweed O, herb Robert O, hog weed O, male fern R, nettle O, meadow buttercup O, meadow vetchling O-LF, nipplewort R, ox eye daisy O, ragwort O, red clover O, ribwort plantain O, rye grass O, self heal R, stone crop LF, white clover O, wood dock O, wood avens LF-F., bittersweet O, violet R, Scrub along the interface with the wooded area and overgrowing grave stones mainly included ivy LF, bramble LF and occasional dog rose (photo P10).
- 4.13 Within the glade areas enclosed by trees (mainly areas L,K, J), the grassland was characteristically more tussocky with fewer forbs than either side of the paths, there were also occasional wood piles and dead wood on the ground with one or two larger trees that had been retained as part of glade clearance works. Species included: barren brome O, cocksfoot F, creeping bent R, creeping Jenny LF, false oat grass O, hedge wound wort R, hogweed O, Japanese knotweed R, meadow buttercup R, Yorkshire fog F, wood avens O-LF, wood dock R.

Tall ruderal

- 4.14 The central part of area Z was an open area with some rubble patches and a mosaic of patches of tall ruderals and garden escapes including creeping thistle LF, black medick F and occasional common vetch, bristly ox tongue, field bind weed, amongst false oat grass, creeping bent and cocksfoot with rarely occurring broad leaved everlasting sweet pea, buddleia, common knap weed, common reed, common mallow, Michaelmas daisy, mugwort, pampas grass, ribwort plantain, wild teasel. This was enclosed by areas of scrub and confined to the area subject to previous tipping.

Secondary woodland, trees and scrub

- 4.15 Secondary woodland/scrub related to the northern part of the site including Areas H3, parts of H2, O1-3, L, J, K, Y1. This was dominated by mostly even aged sycamore saplings forming a dense shade within thickets of bramble scrub submerging an uneven ground with gravestones with some stands of ash and Norway maple saplings LF, and cypress, holly, hornbeam, horse chestnut, lime, yew generally rare in occurrence. Mature/semi mature trees were mainly sycamore with some areas of ash including in H2/3, a number of the more mature trees were

ivy covered. H2/3 also included an area with white willow trees. Larger mature oaks were noted at the south eastern end of O1 and O2 amongst relatively dense stands of ash, Norway maple saplings, and sycamore with a further larger oak with dead wood including woodpecker holes and fallen timber towards the north western end of K (photo P11).

- 4.16 Some clearance of saplings had been undertaken in parts of Y1/H3 to expose gravestones with larger mature oak and ash trees being retained amongst ivy as ground layer and some areas of open canopy where bramble was dominant. In other cleared areas ash saplings were frequent amongst ivy with occasional bushes of elder, hawthorn, holly, and rare occurrences of garden privet and yew. The south eastern part of Y1 included two larger white willow trees amongst ash saplings and there were some poplar trees towards the eastern side of H1/H3. There were a number of central small cleared areas of tree with grassland forming glades (photo P12).
- 4.17 Occasional hawthorn bushes were present with other shrubs including some introduced species: aucubia, Dartford cotoneaster, dog rose, elder, evergreen spindle, honeysuckle, garden privet (LF), snowberry, spindle were generally rare in occurrence.
- 4.18 There were occasional stands of Japanese knotweed throughout the area mainly at the interface of the grassland and wooded areas including at the northern end of areas L, P, the southern end of O2, and in K (photo P13).
- 4.19 Ivy was frequent to abundant as a ground layer also scrambling over gravestones (photo P14) with occasional to rare occurrence of lords and ladies, male fern, wood avens and hogweed where light permitted.
- 4.20 A relatively steeply mounded area formed area Z in the north western part of the Cemetery where scrub had mostly established with the exception of a central open area described under tall ruderal. The scrub was dominated by sycamore saplings with ash and sycamore seedlings and much ivy (LA) with a fallen willow tree and patches of bramble and occasional buddleia, evergreen spindle R, firethorn R, hornbeam, holly R, Norway maple R, snowberry R.
- 4.21 On the south eastern edge of area Z near the base of the mounding and amongst the dense shade of hornbeam and sycamore saplings, and seedlings of ash and sycamore with an ivy ground layer were patches of dead stems of the parasite broomrape (possibly ivy broomrape for which there is a record in the Cemetery) (photo P15). Patches of bramble scrub were present on the boundary of the area with occasional cow parsley, hog weed and wood avens.

Scrub/tree lines

- 4.22 Scrub/tree lines related to the south eastern and western boundaries with a further section along backs of gardens along the northern boundary. Alongside the Wood Vale wooden close boarded boundary fence was an intermittent row of mature and semi mature trees and saplings including ash, sycamore and lime trees with groups of outgrown suckering elm, and a rare occurrence of birch, horse chestnut, oak mostly growing amongst a variable width of bramble with areas of ivy, the occasional hawthorn bush, and an associated strip of rough grassland with patches of cow parsley. A similar feature was present along the southern boundary with oak, some ivy covered sycamore, acacia, out grown suckering elm suckers, horse chestnut, lime and poplar with a variable width of bramble and the occasional elder bush. The boundary along Overhill Road included a slight raised bank with a line of trees including acacia, horse chestnut, lime, oak at the southern end with bramble and ivy patches re appearing mid way together with out grown suckering elm, ash O and acacia O. The northern part of this boundary woodland scrub restricted access for the survey. Wood avens was locally frequent under some of the trees with cow parsley O.
- 4.23 The trees and scrub in the north west (area Z) was dominated by relatively dense, impenetrable stands of sycamore with ash and sycamore seedlings with an ivy understory ground and patches of bramble. Other more rarely occurring trees included hornbeam, Norway maple, with introduced shrubs including buddleia/butterfly bush, evergreen spindle, firethorn, snowberry.

- 4.24 The northern boundary with backs of residential gardens forming the edge of areas H1 and parts of H2 included some intermittent rows of trees (photo P16) with an area of trees and scrub on a bank to the rear of gardens in Forest Hill Road including ash and Norway maple trees with occasional bramble, dog rose, and plum with mostly ivy as a ground layer. Ivy was present also up certain of the more mature ash trees notably around ash tree number 0666. A semi mature oak and number of ash saplings were present also. There was a crack willow at the interface of the tree/scrub band and the secondary wooded area to the immediate south.
- 4.25 Other areas of scattered scrub included cleared glade areas forming the central part of L and J discussed separately under the woodland heading above.

Fauna

- 4.26 ASW Ecology (2011) bat survey assessment of trees in Area F, E and H recorded three trees with medium or high potential for bat roosts (tree no. 616 in Area F, and trees 661, 667 in Area H), No confirmed bat roosts were reported. A subsequent emergence survey of the trees with potential for roosts in Areas F and H recorded a number of feeding and commuting common pipistrelle but no bat roosts.
- 4.27 The cemetery grounds provide good quality foraging habitat for bats, particularly along the tree and shrub belts along the boundary, and the gladed areas and rides within the woodland area forming the northern part of the site. Some larger trees, especially those with ivy coverings and die back have potential for roosting bat.
- 4.28 The scrub and trees within the cemetery particularly in the northern area provided potential habitat for a number of more commonly occurring breeding birds which are protected when nesting. Birds recorded by Southwark Council included blackbird, blue tit, bullfinch, crow, goldfinch, great tit, house sparrow, pigeon, robin and winter wren.
- 4.29 The scrub and wooded areas provided potential suitable habitat for hedgehog. The dead wood provided potential habitat for invertebrates including stag beetle. Stag beetles lay their eggs underground near logs or stumps of dead trees of a wide range of species, especially oak, but also ash, elm, sycamore, lime, hornbeam, apple and cherry (London Wildlife Trust, 2000).
- 4.30 Some of the rougher areas of grassland with a mosaic of scrub, particularly area Z, had potential for use by reptiles and amphibians such as common lizard and common toad, with piles of dead wood providing potential refugia. However, the only record within the cemetery is for common toad. The lack of any record within the cemetery or adjacent area suggests that reptiles are less likely.

Discussion including Nature conservation interest

- 4.31 The majority of the site consisted of common and widespread habitats which are easy to re-establish such as amenity and poor semi-improved grassland and secondary woodland of little nature conservation interest per se. The site is of Borough Importance (Grade I) for nature conservation, its importance comes mainly from its relative extent and location in an otherwise built up area/urban context and therefore is important to the local community. It is a Green Chain Park which is an open space forming part of the Green Chain Link, a walk connecting open spaces in Dulwich and Nunhead into the South East London Green Chain. It also has a potential important role as nearby connecting habitat to the adjacent Horniman Nature Trail Site of Borough Importance and Brenchley Gardens Site of Borough Importance.
- 4.32 The grassland included crow garlic which is apparently relatively uncommon in the Borough and is not listed as occurring in the area on the London Natural History Museum (2011) postcode plants database which sources its data from the Atlas of the British Flora, 3rd edition. Other species although not rare have interest on account of their urban location including the broome rape, and creeping Jenny. Creeping Jenny was relatively extensive component of the semi improved grassland and is a species associated with damp shaded places however it may be a garden escape. Dartford cotoneaster is of local interest as an introduced native.
- 4.33 The vegetation composition of area Z in the west is typical of abandoned brown field sites with a mix of substrates.

- 4.34 The secondary woodland with bramble and ivy understorey and dead wood in the north of the Cemetery is likely to support breeding birds and possibly roosting and foraging pipistrelle bat, hedgehog, stag beetle and sheltering amphibians/reptiles. Bullfinch has been recorded in the cemetery and is a UKBAP species which nests in thick scrub. This area therefore provided local nature conservation interest to the site. It is also listed as supporting speckled wood butterfly and meadow brown butterfly which are flagship species under the local woodland and open spaces habitat action plans.
- 4.35 The scattered mature trees, and scrub belts with extant dead wood around the cemetery in association with areas of rough maintained grassland also provide some local nature conservation interest and have potential as hedgehog, stag beetle, nesting bird and foraging/possible roosting bat habitat. Birds are protected during nesting and all bat species are European protected species (Appendix III).
- 4.36 The species-poor semi-improved and rougher grassland in Areas M, S, Q4, W1, W4, Y, Y1, Z, X and the woodland glades/rides provide some slightly more diverse grassland with potential for invertebrates and foraging and sheltering amphibians and reptiles. If present, common toad may use peripheral longer grass and scrub around the site. If present, common lizard is more likely to use the north western parts of the cemetery. All reptiles are protected from killing/injuring under the Wildlife and Countryside Act (Appendix III).
- 4.37 A more extensive type of management appears to be adopted along the boundaries and in grassland areas also of benefit to invertebrates however much of the grassland where this is being undertaken has a low species diversity.
- 4.38 Patches of Japanese knotweed were recorded in a number of locations mostly in the northern parts of the Cemetery. This is classed as a notifiable weed under the Wildlife and Countryside Act 1981 and it is an offence to "plant or otherwise cause to grow in the wild". Vegetative material and contaminated soil is classed as 'controlled waste' under the section 43 of Environmental Protection Act, 1990 (Appendix III).
- 4.39 Overall, the Cemetery provides a part wooded area with a semi natural appearance and a network of paths of value in an urban context, in particular on account of the woodland character.

5 RECOMMENDATIONS: CONSTRAINTS AND OPPORTUNITIES

Introduction

- 5.1 Routine excavations for burials are small-scale but can be frequent and cumulative. Depending on the extent and location, the impact on nature conservation interest will vary. The impact is likely to be minimal if restricted to smaller areas of regularly maintained amenity or semi-improved grassland. The time frame for reburials relates to around 75 years allowing time for a rotation of planned natural regeneration. Opportunities to integrate nature conservation with routine burial are given below.
- 5.2 In extending the burial capacity of the cemetery, some more major earthworks and habitat/land use changes may be required, and in this case further surveys and mitigation procedures are recommended where necessary.
- 5.3 The potential areas of constraints and opportunities for re-use of burial areas are discussed below.

Opportunities to integrate burial and nature conservation

- 5.4 The different types of burial procedures have varying impacts on the surrounding habitats. Scattering/burial of ashes with a plaque is an option with low impact, depending on long-term maintenance of the area, although it may result in nutrient enrichment of the surrounding soil. Arguably, in the case of Camberwell Old Cemetery the extensive cover of ivy and brambles in wooded areas suggest that the soils are already likely to be enriched and therefore this is unlikely to be an issue. This option of scattering/burial of ashes is recommended in the northern wooded areas with mature oaks including those with die back where deep burial would affect tree roots.
- 5.5 Natural burial (burial of the body without a headstone) requires deep excavation however the surface vegetation can be restored and then managed as habitat for wildlife without the need for grave maintenance. Therefore this option also has a relatively low impact in the long term and would be appropriate in areas of semi improved grassland.
- 5.6 Use of headstones only, rather than a full kerb-set memorial, would potentially provide more opportunities for nature conservation as it leaves a larger area of grassland which can be managed with wildlife in mind, although in the short to medium term visitors to the grave may want to maintain the immediate area as they chose.
- 5.7 Inverting turf and leaving graves to re-colonise naturally or seeding with a wildflower mix following burial provides a method to increase diversity of plants and thereby invertebrates in the cemetery. This would also encourage growth of colourful ephemeral species such as autumn hawkbit and bird's-foot trefoil on which the larvae of six-spot burnet moths feed (a flagship species in the parks and open spaces local habitat action plan). Alternatively strips of wildflowers including legumes (such as bird's-foot trefoil, meadow vetchling and clover) and species such as ox eye daisy and creeping Jenny could be seeded or transplanted as inoculants from areas semi improved grassland elsewhere.
- 5.8 Erection of full kerb-set memorials restricts the areas of grassland/wildflowers that can be maintained between graves and can result in greater loss of habitat if filled with gravel/other hard surfaces, although over time these may colonise naturally.
- 5.9 Areas of semi improved grassland were mainly associated with the historic monument area in the central areas (X, W1, Y, Y1, S, U) with it being possible to integrate restoration with the maintenance of the more diverse areas of the grassland sward both around and within kerbstone areas through a process of the identification of indicator species. More extensive management of the grassland allowing the flowering of the forbs would be beneficial in these areas.
- 5.10 The wooded northern area formed an essential part of the character of the cemetery. However, the present woodland is mostly of relatively recent origin with dense saplings. The grasslands areas either side of the paths provide an interface with the wooded edge and should be maintained as such with the occasional cutting back of encroaching scrub from the wooded

area so as to maintain areas of dappled shade to benefit species such as the speckled wood butterfly. However, there is further scope to remove internal areas of sapling growth whilst maintaining the structure of mature trees, in particular locally occurring native species ash, hornbeam, oak, willow, and yew.

- 5.11 To maintain the general woodland cover within the cemetery an overall strategy is required such that there is a rotation of cleared areas of woodland, and abandonment and regeneration of woodland elsewhere within an overall framework of retaining mature trees. New trees could be planted around the woodland edge and boundary areas, and dedicated/sponsored for revenue. Bird nesting boxes could also be installed on larger retained trees and buildings, and if lack of space limits new tree planting, these bird boxes could be sponsored.
- 5.12 Production of a cemetery conservation management plan, also recommended by English Heritage (2007), would aid effective integration of management/maintenance of the historic and functional aspects of the cemetery with nature/wildlife conservation. Use of interpretative signs around the cemetery in areas to be managed for wildlife would also aid public understanding and support of management regime changes.

Opportunities to extend burial capacity

- 5.13 Areas of improved grassland in the southern, south western, south eastern and north western parts of the Cemetery area provide few constraints for re-use of burial areas except for a number of mature trees with burials needing to avoid excavation of the roots in particular of native species and fine arboricultural specimens of introduced species. However to provide effective open areas for burial some consolidation of trees may be required with a specialist survey to assist with their identification. A survey of bat potential should be undertaken of those trees identified for removal.
- 5.14 In the longer term, a programme of relaxed management could be undertaken to the amenity grassland to allow establishment of scrub woodland through natural regeneration and as part of a wider strategy to compensate for areas of woodland removed in the northern area as part of the long rotational management. This emphasises the need to plant native locally occurring species of trees. The current management practice of leaving fallen trunks of trees on the ground should be continued.
- 5.15 Area Z in the north west included much immature tree growth, with the exception of the boundary areas. Although the more open ruderal area in the centre was reasonably diverse it is likely develop as a more uniform habitat on account of being colonised by sycamore scrub. This provides a potential area for early clearance and burial.

Constraints to further burial

- 5.16 The lines of scrub and trees with an associated rough grassland margin surrounding the peripheries of the site should be retained as far as possible to maintain habitat connectivity around the edge of the cemetery and to provide enclosure from adjacent roads. Occasional selective thinning of trees to favour native species will be necessary to enable the development of mature specimens.

Japanese knotweed

- 5.17 Japanese knotweed is an invasive alien weed. Small fragments of stems and roots are highly regenerative and will readily grow into new plants, therefore it can easily be spread following excavation or cutting, for example in boot cleats or tyre treads. Roots can extend up to 7m from the aerial parts of plant therefore following a more detailed survey in the summer period a 7m zone around the all patches in the northern area and elsewhere should be fenced off and labelled to ensure no works are carried out in the fenced off area to reduce the risk of spreading it further with treatment undertaken. A Japanese knotweed management plan should be drawn up by a specialist in order to prevent its spread and ultimately eradicate the plant.
- 5.18 Japanese knotweed vegetative material and contaminated soil is classed as 'controlled waste' under the section 43 of Environmental Protection Act, 1990, and therefore any arisings not

retained on site must be destroyed on site or disposed of at a licensed landfill site in accordance with the Environmental Protection (Duty of Care) Regulations, 1991 (as amended 2003).

General mitigation procedures

- 5.19 General mitigation measures have been listed below and would apply to Areas F, F1 and H1 which have been identified for re- use of burial within the short term.
- 5.20 Trees and scrub should be removed outside the breeding bird season or following a check for nesting birds. If nesting activity is recorded the habitat should be left in tact until the young have fledged. Semi-mature or mature trees should also be checked for bat potential prior to removal (see Further Surveys).
- 5.21 Depending on the results of the reptile survey in Area Z (see Further Surveys), a mitigation plan may need to be drawn up to avoid killing or injuring reptiles in these areas if any extensive excavations are planned. Mitigation may include measures such hand searches and habitat manipulation (cutting vegetation short prior to excavation) outside of the winter hibernation period.
- 5.22 Dead wood including stumps should be retained in-situ where possible or moved to the edge of the woodland/scrub patches and stacked in partially buried piles to provide habitat for invertebrates, reptiles and amphibians. Where it is necessary to remove larger more mature trees consideration should be given to ring barking to create 'natural' standing timber in areas where health and safety permits. Removal of under storey vegetation should be undertaken carefully to avoid killing hedgehogs if present, and leaf litter should be retained where possible.
- 5.23 Mature oak trees should be retained where possible as flagship species with high biodiversity value.

Recommendations for mitigation within areas F/F1 and H1 in relation to proposals

- 5.24 Proposals for re use of areas F and F1 include raising levels and consequential removal of areas of trees and shrubs including along the boundary. Replacement tree and shrub planting and the re establishment of wildflower grassland is proposed as part of the landscape proposals. Along the boundary tree and shrub planting should include ash, field maple, holly, oak, hornbeam and yew as trees with shrub species including elder, field maple, hawthorn, holly, privet, willow, spindle with creepers including along the fence dog rose, honeysuckle, ivy.
- 5.25 A bank is proposed along the outer edge of the re used area. To provide localised variations the grading of the bank should include localised variation to the profile to incorporate small hollows which may become water logged, and where there is a sunny aspect small vertical banks to benefit soil boring invertebrate. Wildflower grassland would be established over sub soil with a mix of areas seeded and supplemented by planting wildflower plugs. Certain patches should be left bare for natural colonization and these could incorporate placed trunks of felled trees.
- 5.26 The report relating to the bat survey (AWS Ecology, 2011) provides recommendations with respect to tree works and these should be followed.
- 5.27 On account of the loss of some mature trees, the addition of bird and bat boxes should be made on those mature trees remaining.
- 5.28 Many of the recommended mitigation measures for example plug and tree planting could be undertaken as part of a community project involving the local community including youth groups. Tree and bird boxes could form sponsored memorials.
- 5.29 Limited interpretation signage is recommended to incorporate nature conservation and historic interests of the Cemetery.

Further surveys

- 5.30 A reptile survey is recommended if any major works (including for example extensive topsoil removal/excavation/ground works) are planned in the western area of the cemetery, including in areas Z. Results of the survey would be used to indicate likely impact of the proposed works on any reptiles present, and inform development of a mitigation strategy.
- 5.31 The survey for bat should be updated in respect of trees removed in areas F, F1 and H after 2012.
- 5.32 Elsewhere, if any additional large semi-mature to mature trees with potential for bat are to be removed, a daytime inspection by a licensed bat worker should first be required to look for signs of bat and determine how favourable the structures were for use as a bat roost. Follow up night-time (dusk and dawn) emergence surveys may also be required in the summer period to confirm presence or likely absence. If a bat roost is to be affected, a licence would be required from Natural England.

REFERENCES

- ASW Ecology** (2011a) A bat assessment of selected trees at Camberwell Old Cemetery and Camberwell New Cemetery
- ASW Ecology** (2011b) A bat emergence survey of selected trees in areas F and H in Camberwell Old Cemetery
- BSBI** (2007) BSBI List of British & Irish Vascular Plants and Stoneworts
- Defra** (2011) *Biodiversity 2020: A strategy for England's wildlife and ecosystem services*. DEFRA
- Diocese of London** (2011) *In depth advice by topic: Biodiversity action plans/ Churchyards and wildlife/ Trees in churchyards* (<http://www.london.anglican.org/DACInDepthAdvice>; accessed 2nd November 2011).
- EC** (2011) *Our life insurance, our natural capital: An EU biodiversity strategy to 2020*
- English Heritage** (2007) *Paradise preserved: an introduction to the assessment, evaluation, conservation and management of historic cemeteries*
- GLC** (date unknown) *Ecology handbook No. 4: A nature conservation strategy for London – woodland, wasteland, the tidal Thames and two London boroughs*
- Lewisham Council** (2011) *Unitary development plan* (<http://www2.lewisham.gov.uk/lbl/planning/udp/schedule2.html>; accessed 26th October 2011)
- London Biodiversity Partnership** (2011) *London's Biodiversity Action Plans* (<http://www.lbp.org.uk/londonhabspp.html>; accessed 18th October 2011)
- London Borough of Southwark** (2006-2010) *Biodiversity Action Plan: work for wildlife*
- London Borough of Southwark** (2011) *Proposals map* (http://maps.southwark.gov.uk/connect/southwark.jsp?info=Core_Strategy&mapcfg=CoreStrategy; accessed 26th October 2011)
- London Ecology Unit** (1989) *Nature conservation in Southwark: Ecology handbook 12*
- London Natural History Museum** (2011) *Postcode plants database* (<http://www.nhm.ac.uk/fff/>; accessed 7th December 2011)
- London Wildlife Trust** (2000) *Stag beetle: an advice note for its conservation in London*
- National Biodiversity Network Gateway** (2011) (<http://data.nbn.org.uk>; accessed 21st October 2011)
- Nature Conservancy Council** (1990) *Handbook for Phase 1 habitat survey: a technique for environmental audit*.
- Southwark Council** (2011) *Core Strategy*
- Stace C.** (2010) *New flora of the British Isles, 3rd ed.* Cambridge University Press, Cambridge
- Greater London Authority** (2011) *The London Plan: Spatial development strategy for Greater London*
- UK Biodiversity Partnership** (2007) *Conserving biodiversity – the UK approach*. DEFRA

APPENDIX I: PHOTOSHEET – OLD CEMETERY



P1: Recent burials



P2: Area Q1 with rough grass and some more frequently mown paths, including mature and recently planted ornamental trees



P3: Fallen tree retained in grassland in area F



P4: Cleared area along eastern boundary of area E showing former pollarded plane tree



P5: High density of kerb stone graves amongst semi-improved grassland in central part of the Cemetery area Y1



P6: Cover of stonecrops within chippings of kerb stone



P7: Kerbstone grave colonised by grassland



P8: Semi-improved grassland path within wooded area K/J



P9: Semi-improved grassland covering tarmac path in wooded area K/J



P10: Scrub along the interface with the wooded area and overgrowing grave stones



P11: Larger oak towards north western end of Area K with dead wood including woodpecker holes and fallen timber



P12: Area Y1, showing one of several small glades formed by clearing of trees



P13: Stand of Japanese knotweed area K



P14: Ivy scrambling over gravestones typical of areas J/K



P15: Patch of dead stems of parasite broomrape (possibly ivy broomrape) area O1



P16: Intermittent row of trees along northern boundary of H1

APPENDIX II: SPECIES LIST

Common name	Scientific name
Acacia	<i>Acacia sp.</i>
American willowherb	<i>Epilobium ciliatum</i>
Apple	<i>Malus spp</i>
Ash	<i>Fraxinus excelsior</i>
Aucuba	<i>Aucuba japonica &spp</i>
Autumn hawkbit	<i>Leontodon autumnalis</i>
Barren brome	<i>Anisantha sterilis</i>
Birch	<i>Betula sp.</i>
Bittersweet	<i>Solanum eleagnifolium</i>
Black medick	<i>Medicago lupulina</i>
Black poplar	<i>Populus nigra</i>
Bramble	<i>Rubus fruticosus agg.</i>
Bristly ox-tongue	<i>Picris echiioides</i>
Broad leaved everlasting sweet pea	<i>Lathyrus latifolius</i>
Broomrape	<i>Orobanche minor</i>
Buddleia	<i>Buddleja davidii</i>
Buttercup	<i>Ranunculus acris</i>
Cherry	<i>Prunus sp.</i>
Cleavers	<i>Galium aparine</i>
Cock's-foot	<i>Dactylis glomerata</i>
Common bird's-foot trefoil	<i>Lotus corniculatus</i>
Common dog violet	<i>Viola riviniana</i>
Common knapweed	<i>Centaurea nigra</i>
Common mallow	<i>Malva sylvestris</i>
Common reed	<i>Phragmites australis</i>
Common sedge	<i>Carex nigra</i>
Common sorrel	<i>Rumex acetosa</i>
Common vetch	<i>Vicia sativa</i>
Cow parsley	<i>Anthriscus sylvestris</i>
Crack willow	<i>Salix fragilis</i>
Creeping bent	<i>Agrostis stolonifera</i>
Creeping buttercup	<i>Ranunculus repens</i>
Creeping cinquefoil	<i>Potentilla reptans</i>
Creeping Jenny	<i>Lysimachia nummularia</i>
Creeping thistle	<i>Cirsium arvense</i>
Crow garlic	<i>Allium vineale</i>

Cypress	<i>Cupressus/Chamaecyparis sp.</i>
Daisy	<i>Bellis perennis</i>
Dartford cotoneaster	<i>Cotoneaster obtusus</i>
Dog rose	<i>Rosa canina</i>
Elder	<i>Sambucus nigra</i>
Elm	<i>Ulmus sp.</i>
Evergreen spindle	<i>Euonymus japonicus</i>
False oat-grass	<i>Arrhenatherum elatius</i>
Field bindweed	<i>Convolvulus arvensis</i>
Firethorn	<i>Pyracantha sp.</i>
Garden privet	<i>Ligustrum ovalifolium</i>
Germander speedwell	<i>Veronica chamaedrys</i>
Greater plantain	<i>Plantago major</i>
Hawkweed oxtongue	<i>Picris hieracioides</i>
Hawthorn	<i>Crataegus monogyna (agg)</i>
Hazel	<i>Corylus avellana</i>
Hedge bindweed	<i>Calystegia sepium</i>
Hedge woundwort	<i>Stachys sylvatica</i>
Hedgerow crane's-bill	<i>Geranium pyrenaicum</i>
Herb Robert	<i>Geranium robertianum</i>
Hogweed	<i>Heracleum sphondylium</i>
Holly	<i>Ilex aquifolium</i>
Honeysuckle	<i>Lonicera periclymenum</i>
Hornbeam	<i>Carpinus betulus</i>
Horse chestnut	<i>Acer pseudoplatanus</i>
Ivy	<i>Hedera helix</i>
Ivy broomrape	<i>Orobanche sp (possibly hederæ)</i>
Japanese knotweed	<i>Fallopia japonica</i>
Lime	<i>Tilia sp.</i>
Lords and ladies	<i>Arum maculatum</i>
Male fern	<i>Dryopteris filix-mas</i>
Meadow buttercup	<i>Ranunculus acris</i>
Meadow vetchling	<i>Lathyrus pratensis</i>
Michaelmas daisy	<i>Aster novi-belgii</i>
Mugwort	<i>Artemisia vulgaris</i>
Nettle	<i>Urtica dioica</i>
Nipplewort	<i>Lapsana communis</i>

Norway maple	<i>Acer platanoides</i>
Oak	<i>Quercus robur</i>
Oxeye daisy	<i>Leucanthemum vulgare</i>
Pampas grass	<i>Cortaderia selloana</i>
Pendulous sedge	<i>Carex pendula</i>
Plane	<i>Platanus sp.</i>
Plum	<i>Prunus spp</i>
Poplar	<i>Populus sp.</i>
Ragwort	<i>Senecio jacobaea</i>
Red clover	<i>Trifolium pratense</i>
Reflexed stonecrop	<i>Sedum rupestre</i>
Ribwort plantain	<i>Plantago lanceolata</i>
Rose (ornamental)	<i>Rosa sp.</i>
Rosebay willowherb	<i>Chamerion angustifolium</i>
Rye grass	<i>Lolium sp.</i>
Selfheal	<i>Prunella vulgaris</i>
Snowberry	<i>Symphoricarpos albus</i>
Spindle (introduced)	<i>Euonymous sp.</i>
Stonecrop	<i>Sedum sp.</i>
Sycamore	<i>Acer pseudoplatanus</i>
Tasteless stonecrop	<i>Sedum sexangulare</i>
Teasel wild	<i>Dipsacus fullonum</i>
Thyme leaved speedwell	<i>Veronica serpyllifolia</i>
Violet	<i>Viola sp.</i>
White clover	<i>Trifolium repens</i>
White stonecrop	<i>Sedum album</i>
White willow	<i>Salix alba</i>
Whitebeam	<i>Sorbus sp.</i>
Wood avens	<i>Geum urbanum</i>
Wood dock	<i>Rumex sanguineus</i>
Yarrow	<i>Achillea millefolium</i>
Yew	<i>Taxus baccata</i>
Yorkshire fog	<i>Holcus lanatus</i>

APPENDIX III: SUMMARY OF LEGISLATION

Note: this summary does not represent a legal opinion

Great crested newt and bat

Great crested newts and all bat species are fully protected by the Wildlife & Countryside Act 1981 (as amended) and by The Conservation of Habitats and Species Regulations 2010.

These make it an offence to:

- Deliberately or intentionally kill, injure or take an animal of the species or its eggs;
- possess or control any live or dead specimen or anything derived from a great crested newt or bat;
- damage or destroy or intentionally or recklessly obstruct access to any structure or place used for shelter or protection by a great crested newt/bat;
- deliberately, intentionally or recklessly disturb a great crested/bat newt while it is occupying a structure or place which it uses for that purpose.

Works that would result in any of the activities listed above including for example destruction of habitat may be undertaken subject to the granting of a European Protected Species (EPS) licence under Regulation 53 of the Habitats Regulations, and issued by Natural England. The licence must be accompanied by a method statement, and a reasoned statement of application showing how the proposals meet the three tests. The method statement should address how an equivalent population of great crested newt/bat will be maintained as a result of the activities.

Reptile

All reptiles are protected under the wildlife legislation in the Wildlife and Countryside Act 1981 (as amended) protects these species against intentional killing and injuring (under part of Section 9(1) and Section 9(5)).

Breeding bird

Subject to the provisions of part 1 of the Wildlife and Countryside Act 1981 (as amended) it is an offence to intentionally:

- a) kill, injure or take any wild bird
- b) take damage or destroy the nest of any wild bird
- c) take or destroy an egg of any wild bird

Japanese knotweed

Japanese knotweed is classed as a modifiable weed under the Wildlife and Countryside Act 1981. It is an offence to "plant or otherwise cause to grow in the wild" which has implications for control methods e.g. flailing can cause further spread and disposal.

Vegetative material and contaminated soil is classed as 'controlled waste' under the section 43 of Environmental Protection Act, 1990, and therefore must be disposed of at a licensed landfill site in accordance with the Environmental Protection (Duty of Care) Regulations, 1991 (as amended 2003).

Southwark Council

Camberwell New Cemetery,
Southwark: Ecological
assessment

October 2011

Catherine Bickmore Associates Ltd

ENVIRONMENTAL CONSULTANCY

LFG - 5, Lafone House,
11 - 13 Leathermarket Street,
London, SE1 3HN

Tel: 020 7357 6700

E-mail: info@bickmoreassociates.co.uk

Website: www.bickmoreassociates.co.uk

CONTENTS

SUMMARY	1
1 INTRODUCTION.....	2
2 SURVEY METHODS.....	3
3 DESK STUDY FINDINGS	4
4 FIELD SURVEY FINDINGS	7
5 RECOMMENDATIONS: CONSTRAINTS AND OPPORTUNITIES	11
REFERENCES.....	15
APPENDIX I: PHOTOSHEET – NEW CEMETERY.....	16
APPENDIX II: SPECIES LIST	18
APPENDIX III: SUMMARY OF LEGISLATION.....	20

Drawings

645/02 Camberwell New Cemetery: Phase one habitat survey

645/03 Camberwell New Cemetery: Constraints and opportunities

SUMMARY

An ecological assessment has been carried out at Camberwell New Cemetery, Southwark, in connection with plans to expand the burial capacity. A phase one habitat survey was undertaken and a general overview of habitats on the whole site is presented, with additional detail regarding Area D in the south west where additional burial capacity is specifically being considered.

The cemetery is a Site of Borough Importance (Grade II) for nature conservation however its importance comes mostly from its location and extent as an area of open space within an otherwise built up area. The majority of the site consists of amenity grassland and species-poor semi-improved grassland between graves with a large central amenity grassland/sports ground. These habitats are of little conservation interest. A wooded area in the south western part of the site forms the edge of the woodland on the adjacent One Tree Hill Site of Borough Importance (Grade I), and is likely to support breeding birds and possibly roosting and foraging bats, hedgehog, stag beetle and sheltering amphibians/reptiles and therefore provides local nature conservation interest to the site. Scattered trees, hedgerows and scrub belts around the site also provide local conservation interest and potential for birds.

Potential areas for additional burial are considered, and recommendations are given to minimise the impacts of expansion on features of nature conservation interest. Opportunities to enhance biodiversity within the cemetery site are also identified including production of a management plan.

1 INTRODUCTION

- 1.1 Catherine Bickmore Associates were commissioned on 18th July 2011 on behalf of Southwark Council to undertake a phase one ecological survey of Camberwell New Cemetery, London, SE23 3RD. The aim of the survey was to determine constraints and opportunities with regards to nature conservation in connection with plans to create additional space for burial within the cemetery grounds.
- 1.2 The New Cemetery (18.4ha) is located in a residential area adjacent to Honour Oak Park station with a side entrance from Honour Oak Park and the main entrance to the chapel (centred on grid reference TQ358745) from Brenchley Gardens.

Outline

- 1.3 Survey methods including desk study data collection and field survey are outlined in Section 2, with desk study findings presented in Section 3 and field survey results described in Section 4 with an assessment of nature conservation interest. Constraints and opportunities with regards to expanding burial area and improving nature conservation interest of the cemetery are given in Section 5. Appendices include a species list and photographs of the habitats on site followed by a summary of relevant legislation.

2 SURVEY METHODS

Desk study

- 2.1 Biological records were obtained from Southwark Council who provided a species list for the cemetery and a description from the 1995 ecological survey of the cemetery as a site of borough importance (grade II). The old maps (2011) website was consulted for historical maps of the area and Magic Map and Natural England's Nature on the Map webpages were checked for site designations.
- 2.2 Further information regarding sites of nature conservation interest was obtained from the London Borough of Southwark Biodiversity Action Plan 2006-2010 and London Borough of Southwark (2011) and Lewisham Council (2011) local plans and proposal maps.

Field survey

- 2.3 A site visit was undertaken on 7th September 2011, a cloudy, mostly dry day, by a qualified ecologist. The field survey method followed phase one habitat survey procedures in Nature Conservancy Council (1990) and comprised a walk over of the site recording main habitat types and species present using the DAFOR¹ scale (Nature Conservancy Council, 1990).
- 2.4 Features of note were described and plotted on a plan along with the main habitat types (drwing 645/02). A broad description is given in the text of the habitats across the site, with a more detailed description of Area D where cemetery expansion is planned. Common names are used throughout the text with scientific equivalents for flora listed in Appendix II, applying BSBI (2007) or Stace (2010) nomenclature.
- 2.5 The survey was subject to access and seasonal constraints reflecting the conditions on site at the time of the survey. September is too late to record vernal species however conditions were suitable for the purpose of the survey. There was no access to Area O (Drwing 645/02).

¹ D = dominant; A = abundant; LA = locally abundant; F = frequent; LF = locally frequent; O = occasional; R = rare

3 DESK STUDY FINDINGS

Biological records

Site context and history

- 3.1 The New Camberwell Cemetery covers c.18.4ha and is located close to Honour Oak Park station (drawing 645/02). The Cemetery is bounded by allotments to the south west, by One Tree Hill Site of Nature Conservation Importance (SNCI) and Local Nature Reserve (c.6.8ha) to the south west, and Forest Hill to New Cross Gate Railway Cutting SNCI to the south east. Immediately to the east, in the northern part of the cemetery, is a crematorium and garden of remembrance. Residential development/roads border the north west and northern boundaries of the cemetery.
- 3.2 The cemetery itself forms part of a Site of Borough Importance and is also a Green Chain Park in the Southwark Core Strategy (Southwark Council, 2011), and is therefore protected as an important open space under Policy 11.
- 3.3 The majority of the site is relatively flat however the ground rises fairly steeply in the south west towards One Tree Hill, and slopes gently down at the northern edge towards Brockley Way.
- 3.4 Camberwell New Cemetery opened on the site of the former Honour Oak and Forest Hill golf course in 1927 (London Ecology Unit, 1989). Historical maps show the adjacent One Tree Hill area first appearing wooded in 1919, with no trees shown in the previous 1898 map (Old Maps, 2011).

Sites of nature conservation interest

- 3.5 Sites of Importance for Nature Conservation are those sites which contain the best examples of habitats or rare species/assemblages of species or important populations of species or sites which are of particular significance in being in an otherwise heavily built up area. Sites of Metropolitan Importance are significant on a London-wide scale while Sites of Borough Importance are important from a borough perspective. Borough sites are divided into two categories, Grade I and Grade II, according to their quality, however all are important at a borough-wide scale.
- 3.6 Sites of nature conservation interest are protected under the London Plan (Greater London Authority, 2011) which states that sites should be given a level of protection commensurate with their importance and adverse impacts on the biodiversity interest should be avoided or minimised and mitigated/compensated.
- 3.7 The Cemetery is a Site of Borough Importance (Grade II) named Camberwell New Cemetery, Honour Oak Crematorium and adjacent area (So.BII 5). The site covers 19ha and includes the allotments to the south. It is also designated as Metropolitan Open Land (Os145).
- 3.8 The key habitat/species of the Site of Borough Importance are listed as secondary woodland, hedges, mature trees and common lizard (associated with the allotments), and the objective for the site is to manage the boundaries for wildlife (London Borough of Southwark, 2006-2010). London Ecology Unit (1989) description of the site considers that the wooded slopes in the south west of the cemetery, bordering One Tree Hill, is the area of highest nature conservation interest with rough grassland, woodland and scrub. Southwark Council's 1995 ecology survey mentions dense shrubberies, mature trees and a pond providing habitat in the crematorium to the east which adjoins woodland on the adjacent railway cutting.
- 3.9 Forest Hill to New Cross Gate Railway Cutting Site of Metropolitan Importance lies immediately adjacent to the east of the central and southern part of the cemetery (adjacent to the tennis and basketball courts). It is listed as containing 'probably the finest suite of railside habitats in London', including woodland, scrub, acid and neutral grassland and reedbeds (Lewisham Council, 2011).
- 3.10 Two other Sites of Borough Importance border the cemetery including One Tree Hill which is a Grade 1 ecological site and Local Nature Reserve with relict acid grassland and secondary

woodland (London Ecology Unit, 1989) immediately to the west (some tiny tracts are recognised as ancient woodland (Southwark Biodiversity Action Plan)), and Brenchley Gardens (2.9ha) which is a Grade 2 ecological site including a garden with woodland and grassland situated to the north west on the opposite side of Brenchley Gardens road (Southwark Biodiversity Action Plan). Brenchley Gardens provides a connective wildlife corridor to the Camberwell Old Cemetery Grade 1 Site of Borough Importance to the north west. To the east of Brenchley Gardens is Aquarius Golf Course Site of Borough Importance (Grade II) (2.4ha) consisting of neutral grassland over a covered reservoir.

- 3.11 There are no statutory internationally or nationally important sites for nature conservation within 5km of the cemetery.

Protected species

- 3.12 A bat emergence survey in September 2011 at Camberwell Old Cemetery, c. 0.5km to the south west of the new cemetery, recorded foraging common pipistrelle (ASW Ecology, 2011b). The trees in Area D in Camberwell New Cemetery were also checked during daylight in summer 2011 for bat roosts, and although no bat roosts were confirmed, two trees and one group of trees had potential for bat roosts, including tree 502 and tree 539 and a group of trees in the wooded south west corner (ASW Ecology, 2011a).
- 3.13 Southwark Council's 1995 ecology survey of the cemetery listed common lizard as being present in the allotments to the south of the cemetery. Species present within nature reserves with public access along the Forest Hill to New Cross Gate Railway Cutting Site include slow worm and common lizard, tawny owl, great and lesser spotted woodpecker and sparrowhawk. Stag beetle have been recorded within 1km to the south of the site in 2005. A number of commonly occurring garden birds have also been recorded in the vicinity.

Biodiversity Action Plans

- 3.14 In 2010 the EU agreed to a vision and 2020 mission for biodiversity including protecting, valuing and restoring ecosystem services and biodiversity by 2050 and halting degradation/loss by 2020 (Defra, 2011). The European Commission (2011) have adopted a new EU biodiversity strategy to help meet this goal.
- 3.15 The UK Biodiversity Action Plan outlines the UK's strategic approach to biodiversity conservation which is based on the ecosystem approach along with priority species and habitat action plans (UK Biodiversity Partnership, 2007). It includes a number of potentially relevant habitat and species plans including for hedgerows, lowland mixed deciduous woodland and ponds, and species plans for stag beetle, dormouse, noctule and pipistrelle bats, Western European hedgehog and all reptile species, common toad, great crested newt, along with bird species dunnock, song thrush, common cuckoo, common starling, house and tree sparrow and lesser spotted woodpecker.
- 3.16 Following the overall goals of the EU biodiversity strategy, The England Biodiversity Action Plan sets out the country's overall strategy with regard to biodiversity which is based on an integrated large-scale/landscape approach to conservation with four main outcomes relating to habitats and ecosystem on land and in the sea, species protection and people engagement. The strategy's vision is stated as being:
- “to halt overall biodiversity loss, support healthy well-functioning ecosystems and establish coherent ecological networks, with more and better places for nature for the benefit of wildlife and people.”* (Defra, 2011).
- 3.17 The English Biodiversity Action Plan includes a number of priority actions, one of which is to bring a greater proportion of existing woodlands into sustainable management and to increase the area of woodland in England.
- 3.18 The London Biodiversity Partnership (2011) have developed 11 habitat action plans (HAP) including for woodland, standing water, reed beds, and parks and urban green spaces such as cemeteries, along with a list of other important habitats which have targets but no action plan such as built structures, and open landscapes with old trees. Targets to maintain, enhance and

extend the habitats are given in the London Plan (Greater London Authority, 2011). There are species action plans for bats, reptiles, house sparrows and stag beetles; and a list of other important species including black redstart and common dormouse.

- 3.19 Within the London BAP Parks and Urban Green Spaces HAP is a specific action plan for churchyards and cemeteries. The aims of the action plan are:
- To develop a strategic approach to the protection, management and enhancement of the nature conservation value of cemeteries and churchyards.
 - To respect the primary purpose of cemeteries and churchyards, which is that of burial and as a space to accommodate grieving visitors.
 - To secure the involvement of all London's faiths and communities in the conservation of churchyards and cemeteries, by raising awareness.
- 3.20 Two advice notes regarding wildlife in churchyards and implementation of biodiversity action plans in churchyards and cemeteries is available on the Diocese of London (2011) website. The Diocese of London is also developing a project with the Diocese of Southwark, and they are progressing with fundraising to assess the habitats, fauna and flora in churchyards across the Dioceses of London and Southwark (Diocese of London, 2011).
- 3.21 The local London Borough of Southwark Biodiversity Action Plan 2006-2010 contains habitat action plans to enhance biodiversity in parks and open spaces (including sports fields but not cemeteries) and woodland (including secondary woodland, scrub with trees and hedgerows), and species action plans for bats and stag beetle.
- 3.22 Additional flagship species within the woodland habitat action plan included speckled wood butterfly on woodland edges and glades, oak species and associated purple hairstreak butterfly, greater spotted woodpecker and sparrowhawk.
- 3.23 Additional flagship species within the parks and open spaces habitat action plan included oxeye daisy, rosebay willowherb, buttercups, song thrush, greater spotted woodpecker, holly blue butterfly, meadow brown butterfly and six spot burnet moth.

4 FIELD SURVEY FINDINGS

Overview

- 4.1 The cemetery is divided up into various land uses (drawing 645/02):
- c.4.2 ha (just over one fifth of the cemetery site), the central eastern edge, is taken up by an amenity grass sports ground with tennis/basketball courts and a play area,
 - c. 1.2ha in the south west corner is a currently unused wooded area with some amenity grassland (Area D),
 - c. 0.7ha along the western and northern boundaries of the site are taken up by planted tree and scrub belts,
 - c.0.3ha in the northern-most corner of the cemetery also appears relatively unused with only a few scattered gravestones (Area M),
 - c.0.3ha along the southern edge is undergoing works and is within an inaccessible construction site (Area O),
- the remaining c. 11.7ha of the site is taken up by graveyards with associated car parking, buildings and concrete/tarmac paths, hedges and trees dividing the cemetery into sections.
- 4.2 There is an inevitable gradation between the classifications of amenity, improved and poor semi-improved grassland. The grassland between all the graves appeared fairly regularly cut, however the degree of maintenance appeared to vary between areas resulting in two different grassland classifications: amenity grassland (closely maintained uniform, short grassland with low diversity of grass and few forbs), and poor semi-improved grassland (slightly higher species diversity, rougher grassland, less closely maintained). The semi-improved grassland areas tended to be associated with graveyards of older graves and those with kerb-set memorials which often supported additional species.
- 4.3 The main habitat types are described below.

Amenity grassland

- 4.4 The graveyard at the southern edge of the site (Area A), as well as an area of graves adjacent to the western entrance (Area G), and the sports ground (Photo 6) were the most closely maintained areas of amenity grassland with uniform short grassland, dominated by perennial ryegrass with frequent annual meadow grass/white clover and a few other forbs.
- 4.5 Areas B, H and L were relatively new, well maintained areas of the cemetery, mostly with simple headstones rather than kerb-set memorials, with improved amenity grassland dominated by perennial ryegrass and a few trees and rose bushes between the headstones but generally of little ecological interest (Photo 10).
- 4.6 The southern part of Area M was also fairly regularly mown, uniform amenity grassland with few gravestones, sloping gently down to the north (Photo 8).

Area D

- 4.7 Within Area D, adjacent to the woodland was an area of occasionally mown improved grassland (classified as amenity grassland) dominated by perennial ryegrass with frequent white clover, locally frequent bryophytes and occasional autumn hawkbit, creeping cinquefoil, daisy, greater plantain, ground ivy, hogweed and ribwort plantain. There were also rare occurrences of comfrey and herb Robert in the grassland and a fallen dead cherry tree (Photo 2).

Poor semi-improved grassland

- 4.8 Area I was similar to Areas B, H and L but slightly less closely maintained and with more forbs such as autumn hawkbit adding some colour to the poor semi-improved grassland.
- 4.9 Areas F, J and K were also slightly more diverse areas of graveyard with densely packed older graves, mostly with kerb-set memorials (Photo 11). In these areas additional species were

growing in and around the memorials including occasional common field speedwell, lichen, stonecrop, scarlet pimpernel, procumbent yellow sorrel and common bird's-foot trefoil. The areas were therefore classified as semi-improved grassland, however the grassland in between the graves was still fairly well maintained and species poor (Photo 12).

- 4.10 Area C was similar to F, J and K however the grassland was slightly rougher and less well maintained and had potential for use by foraging reptiles, particularly given the area's proximity to the allotments. The area sloped steeply up to the west and included scattered gravestones in parts and some denser kerb-set memorials with occasional moss and lichen growth in parts. The two plots to the east were raised up on a paving stone-reinforced bank (Photo 5).
- 4.11 Area E also contained older graves with some monuments and some kerb-set memorials around the edge with occasional lichen/bryophyte growth. It included an area of long grassland dominated by false oat grass with occasional meadow vetchling in the centre around a fallen whitebeam tree (Photo 4). This long grassland had potential for invertebrate and herpetofauna species.
- 4.12 The northern part of Area M included rougher, species-poor semi-improved grassland between trees and patches of scrub with occasional occurrences of black horehound, hedgerow crane's-bill, herb Robert, and wood avens amongst other forbs. A standing dead tree was also present with ivy and bracket fungus on the trunk.
- 4.13 Area N, to the east of M, was poor semi-improved grassland with rough, uneven ground including a linear mound of earth, and scattered gravestones and memorials with occasional lichen growth (Photo 9). This area included additional species such as meadow vetchling, redshank and hairy tare. There was common dog violet under the trees along the bank adjacent to the road.

Woodland, hedgerows, trees and scrub

- 4.14 A number of trees both introduced and native species, for example ash, cypress, false acacia, hawthorn, horse chestnut, lime, oak, plane and poplar, including some mature trees, were scattered throughout the cemetery, providing potential habitat for invertebrates, nesting birds and possibly roosting bats in the larger trees with cavities/cracks.
- 4.15 A line of scrub (too wide in places to be classified as a hedgerow) bounded the north western edge of the site. In the southern part of this boundary it formed a garden privet hedge (introduced shrub) with sycamore trees, and in the northern part it consisted of dense scrub with frequent hawthorn, elm and bramble and dead wood piles. Adjacent to the lodge by the western entrance was a patch of dense scrub with frequent ivy and bramble under the horse chestnut and ash trees and frequent introduced euonymous shrubs and dead wood.
- 4.16 Along the northern edge of the site, a firethorn hedge was present along the boundary of Area N with Brockley Way, behind a line of horse chestnut and plane trees. A hawthorn hedge bounded the southern edge of Area N. An area of dense scrub (dominated by bramble) with trees (horse chestnut, poplars and plane trees) was present at the northern boundary of Area M.
- 4.17 Around the trees in Area M were patches of scrub such as bramble, ivy and hawthorn. One of the trees was dead and supported a bracket fungus.
- 4.18 An outgrown hawthorn edge separated the tennis courts from the sports ground in the eastern part of the site (Photo 7). A hedge dominated by elder with frequent hawthorn was also present to the east of the tennis/basketball courts, on the boundary of the site with the adjacent Site of Metropolitan Importance, and included some relatively large patches of the invasive Japanese knotweed (see Appendix III for relevant legislation).
- 4.19 To the north of the tennis courts was an area of overgrown tarmac with scattered scrub (bramble and buddleia) and frequent common reed suggesting ephemerally damp conditions.

Area D

- 4.20 Area D (c.1.2ha) was wooded over c.0.7ha. This included a densely wooded area with bramble and ivy understorey in the south west corner (Photo 1), a strip of trees and bramble along the western edge to the north, and more open woodland including semi-improved grass with tall ruderal vegetation under the canopy in the northern eastern part of the area (Photo 3).
- 4.21 The densely wooded area in the south of Area D contained much fallen dead wood, and the canopy contained frequent English oak, hawthorn, holly and sycamore with occasional ash, elder, poplar and rhododendron. The understorey was fairly low and was dominated by ivy in the southern half and bramble in the northern half with frequent cherry saplings and locally frequent nettle. There were also ash saplings (O), garden privet (O), great willowherb (R), hogweed (R), large bindweed (O), wood avens (O), wood dock (R) and yew saplings (R).
- 4.22 The more open wooded area in the north east of Area D was dominated by ash with occasional oak and birch, and with semi-improved grassland underneath. The grassland was mostly short with longer patches including tall ruderal species, and was dominated by perennial ryegrass with locally frequent upright hedge-parsley and occasional broad-leaved dock, common mallow, creeping buttercup, couch grass, daisy, greater plantain, herb Robert, ribwort plantain, wood avens and wood dock. The patches of tall ruderal vegetation were mostly centred around piles of dead wood and included false oat-grass (D), wood dock (F), cock's-foot (LF) and meadow buttercup (O), bramble (O), cow parsley (O), creeping cinquefoil (O), hairy tare (O), upright hedge parsley (O) and wood avens (O).
- 4.23 The central, western edge of Area D consisted of a belt of woodland joining the denser woodland in the south to the more open woodland in the north. It was similar in character to the dense woodland area to the south however there were more open gaps in the canopy and less dead wood, with occurrences of common vetch (O), creeping thistle (O), hawkweed oxtongue (O), large bindweed (LF), nettle (O) and spear thistle (O) in the gaps, and rare occurrences of dog rose and snowberry. There was a dense patch of bramble adjacent to the more open woodland area in the north with occasional hawthorn, holly and nettle.
- 4.24 There were four patches of scrub at the eastern edge of Area D, separating the improved amenity grassland in Area D from the adjacent memorials and semi-improved grassland of Area C. There was a fallen dead cherry tree adjacent to the second scrub patch (Photo 2). The northern patch included bramble (D), elm scrub/suckers (O), hawthorn sapling (O) and immature ash trees (F); the second patch included a semi-mature sycamore and small cherry trees surrounded by bramble (D), wood avens (O) and a sizeable patch of Japanese knotweed (LF) (see Appendix III for legislation regarding Japanese knotweed); the third patch had dense bramble (D), snowberry (F), hawthorn (F), large bindweed (O) and cleavers (O); and the fourth, southern-most patch consisted of a holly bush with hawthorns and a bramble understorey

Fauna

- 4.25 A sparrowhawk was recorded (by casual observation) roosting in a tree on the western edge of the cemetery and signs of fox were recorded in the northern part of the cemetery. The buildings, scrub and trees on the site provide potential habitat for a number of breeding birds which are protected when nesting. Common birds recorded by Southwark Council include blackbird, blue tit, great tit, green woodpecker, house sparrow, mistle thrush, robin, starling and wood pigeon.
- 4.26 The scrub, hedgerows and wooded areas also provide potential suitable habitat for hedgehog. The dead wood provided potential habitat for invertebrates including stag beetle. Stag beetles lay their eggs underground near logs or stumps of dead trees of a wide range of species, especially oak, but also ash, elm, sycamore, lime, hornbeam, apple and cherry (London Wildlife Trust, 2000).
- 4.27 Parts of the cemetery grounds are likely to provide good quality foraging habitat for bats, particularly along the woodland edge. Some larger trees, especially those with ivy coverings and woodpecker holes have potential for roosting bat, for example in Area D (ASW Ecology, 2011a). The buildings including the chapel and the lodge and toilets had potential for use as bat roosts, however the maintenance building adjacent to the western entrance had a flat roof

and was unlikely to support roosting bats. A specialist survey would be required to confirm presence/absence of bat roosts.

- 4.28 Some of the rougher areas of grassland had potential for use by reptiles and amphibians such as common lizard and common toad, with piles of dead wood providing potential refugia, including in particular Areas C, D, E, M and N. However the relative isolation of Area M and N from connecting habitat means reptiles are less likely in these areas. There was a low probability of great crested newt, a European protected species (Appendix III), using the terrestrial habitat on site as the only waterbody shown on plans with connectivity to the cemetery was an ornamental pond in the adjacent crematorium, c.70m to the east and separated from the site by the crematorium buildings and associated hard standing.

Nature conservation interest

- 4.29 The majority of the site consisted of common and widespread habitats which are easy to re-establish such as amenity and poor semi-improved grassland of little nature conservation interest. Although the site is of Borough Importance (Grade II) for nature conservation, its importance comes mainly from its relative extent and location in an otherwise built up area/urban context and therefore is important to the local community. It is a Green Chain Park which is an open space forming part of the Green Chain Link, a walk connecting open spaces in Dulwich and Nunhead into the South East London Green Chain. It also has a potential important role as buffer/connecting habitat to the adjacent One Tree Hill Site of Borough Importance (Grade I), Brenchley Gardens Site of Borough Importance (Grade II) and Forest Hill to New Cross Gate Railway Cutting Site of Metropolitan Importance.
- 4.30 The wooded area with bramble and ivy understorey and dead wood in the south west (Area D) was secondary woodland, an extension of the woodland on the adjacent One Tree Hill Site of Borough Importance (Grade I), and is likely to support breeding birds and possibly roosting and foraging bats, hedgehog, stag beetle and sheltering amphibians/reptiles. This area therefore provides local nature conservation interest to the site. It is also listed as supporting speckled wood butterfly and oak trees which are flagship woodland species under the local BAP.
- 4.31 The scattered mature trees, hedgerows and scrub belts with dead wood around the cemetery also provide some local nature conservation interest and have potential as hedgehog, stag beetle, nesting bird and foraging/possible roosting bat habitat. Some of the buildings also provided potential nesting/roosting structures. Birds are protected during nesting and all bat species are European protected species (Appendix III). Sparrowhawk was recorded roosting in a tree and is a Southwark BAP flagship species which preys mostly on small birds.
- 4.32 The sports field falls under the local BAP Parks and Open Spaces with the objective of increasing biodiversity in these areas, and the trees fall under the LBAP woodland habitat action plan.
- 4.33 The species-poor semi-improved and rougher grassland in Areas C, D, E, F, J, K, M and N provide some slightly more diverse grassland with potential for invertebrates and foraging and sheltering amphibians and reptiles. If present, common toad may use peripheral longer grass and scrub around the site. If present, common lizard are more likely to use the southern edges of the cemetery which are adjacent to the allotments with a known population of lizard, than the northern edges which are bounded by roads. All reptiles are protected from killing/injuring under the Wildlife and Countryside Act (Appendix III).
- 4.34 Japanese knotweed was recorded on the south eastern boundary of the site and also within Area D. This is classed as a notifiable weed under the Wildlife and Countryside Act 1981 and it is an offence to "plant or otherwise cause to grow in the wild". Vegetative material and contaminated soil is classed as 'controlled waste' under the section 43 of Environmental Protection Act, 1990 (Appendix III).



KEY

- A
- SI
-
-
-
-
-
-
-
-
-
- A-O

- Amenity grassland
- Species-poor semi-improved grassland
- Dense scrub
- Scattered scrub
- Introduced shrub
- Broad-leaved semi-mature woodland
- Scattered trees/tree-line
- Species-poor hedge
- Hardstanding
- Building
- Survey boundary
- Survey areas

Ordnance Survey Licence No. AL100036425

Drawn by	DL	Check by	CB	Date	Oct 2011	Scale	See bar
----------	----	----------	----	------	----------	-------	---------

Camdenwell New Cemetery

Phase one habitat survey

Catherine Bickmore Associates Ltd
ENVIRONMENTAL CONSULTANCY

LFG 5 Lebone House, Leathermarket Street, London SE1 3HN
 Tel: 020 73576700
 E-mail: info@bickmoreassociates.co.uk
 Website: www.bickmoreassociates.co.uk

Drawing number
645/02

Revision



Blanchley Gardens
Site of Borough
Importance (Grade II)

One Tree Hill Local
Nature Reserve and
Site of Borough
Importance (Grade II)

Abolments

info

www.camden.gov.uk

5 RECOMMENDATIONS: CONSTRAINTS AND OPPORTUNITIES

Introduction

- 5.1 Routine excavations for burials are small-scale but can be frequent and cumulative. Depending on the extent and location, the impact on nature conservation interest will vary. The impact is likely to be minimal if restricted to smaller areas of regularly maintained amenity or semi-improved grassland. Opportunities to integrate nature conservation with routine burial are given below.
- 5.2 In extending the burial capacity of the cemetery, some more major earthworks and habitat/land use changes may be required, and in this case further surveys and mitigation procedures are recommended where necessary.
- 5.3 The drawing 645/03 indicates the potential areas of constraints and opportunities to extension of burial discussed below.

Opportunities to integrate burial and nature conservation

- 5.4 The different types of burial procedures have varying impacts on the surrounding habitats. Scattering/burial of ashes with a plaque is an option with low impact, depending on long-term maintenance of the area, although it may result in nutrient enrichment of the surrounding soil. This option is recommended in more sensitive areas such as within the woodland in Area D, where tree roots may also impede deep burial.
- 5.5 Natural burial (burial of the body without a headstone) requires deep excavation however the surface can be restored and then managed as habitat for wildlife without the need for grave maintenance. Therefore this option is also relatively low impact in the long term.
- 5.6 Use of headstones only, rather than a full kerb-set memorial, would potentially provide more opportunities for nature conservation as it leaves a larger area of grassland which can be managed with wildlife in mind, although visitors to the grave may maintain the immediate area as they chose.
- 5.7 Inverting turf and leaving graves to re-colonise naturally or seeding with a wildflower mix following burial would be a way to increase diversity of plants and thereby invertebrates in the cemetery. This would also encourage growth of colourful ruderal and ephemeral species such as autumn hawkbit and bird's-foot trefoil on which the larvae of six-spot burnet moths (a flagship species in the parks and open spaces local habitat action plan) feed. Alternatively strips of wildflowers including legumes (such as bird's-foot trefoil and clover) could be seeded between graves.
- 5.8 Erection of full kerb-set memorials restricts the areas of grassland/wildflowers that can be maintained between graves and can result in greater loss of habitat if filled with gravel/other hard surfaces, although these may colonise naturally over time.

Opportunities to extend burial capacity

- 5.9 The large amenity grassland sports ground at the centre of the cemetery had negligible nature conservation interest and therefore would be ideal for expansion of burial, depending on requirement of extent of the sports ground for sports activities.
- 5.10 The amenity and poor semi-improved grassland between graves in areas A, B, F, G, H, I, J, K and L did not provide any particular nature conservation interest therefore these areas would not be constrained with regards to re-burial.
- 5.11 Areas M and N had a low density of older gravestones and low nature conservation interest and therefore may be suitable for burial expansion. These areas are less constrained by aspects of nature conservation compared to Areas C, D and E to the south as they are less wooded and less connected to adjacent allotments and Sites of Nature Conservation Interest and are therefore likely to be less diverse and less likely to support species such as reptiles and amphibians.

- 5.12 The southern part of Area M consisted of sloping amenity grassland with few existing gravestones and may be suitable for further burial (Photo 8). The northern part of Area M contained poor semi-improved grassland with patches of scrub around trees, including standing dead wood, however the scrub could be cut back providing space for burial between the trees and dead wood. Area N contained more headstones however they were scattered irregularly and may be suitable for reburial (Photo 9).
- 5.13 Areas C, D and E included areas of rougher/longer grassland and scrub and dead wood in proximity with the allotments to the south, therefore extensive methods of re-burial may be constrained by reptiles in these areas (see below).
- 5.14 In the absence of reptiles, or following implementation of mitigation measures, the improved amenity grassland at the edge of the wooded area in Area D would be suitable for further burial as it has low nature conservation interest and few graves. Parts of Area C (Photo 5) and Area E (Photo 4) also appeared to have space for further burial. The open wooded area in the north eastern part of Area D (Photo 3) could be utilised for further burial through selective removal of trees as necessary.
- 5.15 The western and southern parts of Area D were more densely wooded, forming the edge of the secondary woodland in One Tree Hill Site of Nature Conservation Importance and acting as a buffer to this site. Tree roots may restrict burial in this area and parts of this area were fairly steep which may also limit use for burial. However, the understorey flora of the woodland was dominated by bramble and ivy and was fairly species poor, therefore the area offers some potential for further burial. Existing glades penetrating the south eastern edge of the wood could be widened and new glades created in flatter areas to create space for burial while retaining the wooded feel and nature conservation interest of the area and retaining a wooded buffer to One Tree Hill.

Constraints to further burial

- 5.16 The hedgerows and lines of scrub and trees surrounding the peripheries of the site should be retained as far as possible to maintain habitat connectivity around the edge of the cemetery and provide enclosure from adjacent roads.
- 5.17 In area D, the wooded area immediately adjacent to One Tree Hill should be retained as a woodland habitat buffer connecting to the site of nature conservation interest. The patches of scrub including elm and dead wood (particularly the cherry tree stump) should be retained where possible, subject to health and safety, to provide habitat for invertebrates and nesting birds and provide some enclosure to areas of burial adjacent to the woodland. Mature trees should be retained where possible to maintain the wooded feel of the area and enhance biodiversity.
- 5.18 Depending on the results of the reptile survey, mitigation measures may need to be employed before any major excavations are carried out in Areas C, D or E (see 'General Mitigation Procedures').
- Japanese knotweed
- 5.19 Japanese knotweed is an invasive alien weed and is classed as a notifiable weed under the Wildlife and Countryside Act 1981. Small fragments of stems and roots are highly regenerative and will readily grow into new plants, therefore it can easily be spread following excavation or cutting for example in boot cleats or tyre treads. Roots can extend up to 7m from the plant, therefore a 7m zone around the patches in Area D and alongside the sports ground should be fenced off to ensure no works are carried out in the area which would risk spreading it further. The plant will need to be treated and eradicated from the patch of scrub where it was recorded in Area D and from where it is entering the sports ground from the adjacent Site of Metropolitan Importance.
- 5.20 Japanese knotweed vegetative material and contaminated soil is classed as 'controlled waste' under the section 43 of Environmental Protection Act, 1990, and therefore any arisings not retained on site must be destroyed on site or disposed of at a licensed landfill site in accordance with the Environmental Protection (Duty of Care) Regulations, 1991 (as amended

2003). A Japanese knotweed management plan should be drawn up by a specialist in order to prevent its spread and ultimately eradicate the plant.

General mitigation procedures

- 5.21 Trees and scrub should be removed outside the breeding bird season or following a check for nesting birds. If nesting activity is recorded the habitat should be left in tact until the young have fledged. Semi-mature or mature trees should also be checked for bat potential prior to removal (see Further Surveys).
- 5.22 Depending on the results of the reptile survey in Areas C, D and E (see Further Surveys), a mitigation plan may need to be drawn up to avoid killing or injuring reptiles in these areas if any extensive excavations are planned. Mitigation may include measures such as hand searches and habitat manipulation (cutting vegetation short prior to excavation) outside of the winter hibernation period.
- 5.23 In Areas M and N, as a precaution, the grassland should be cut short (<150mm) prior to any major excavations to minimise risk of presence of reptiles and amphibians.
- 5.24 Dead wood including stumps should be retained in-situ where possible or moved to the edge of the woodland/scrub patches and stacked in partially buried piles to provide habitat for invertebrates, reptiles and amphibians. Removal of understorey vegetation should be undertaken carefully to avoid killing hedgehogs if present, and leaf litter should be retained where possible.
- 5.25 Oak trees should be retained where possible as flagship species with high biodiversity value. In Area D, trees should be removed in carefully selected groups in order to minimise the impact on the adjacent wildlife site, and to create glades and increase the area of woodland edge habitat which is valuable in particular to foraging bats, birds, reptiles and invertebrates for example speckled wood butterfly which prefers dappled shade.

Opportunities to enhance biodiversity/nature conservation interest

- 5.26 To improve the nature conservation value of Area D, the structure and biodiversity of the woodland edge could be improved through planting native scrub such as hawthorn, hazel and holly. This would also act as a buffer habitat to the woodland, and the area would be further enhanced through less intensive maintenance of scrub and grassland at the woodland edge.
- 5.27 The grassland edges to the woodland and scrub patches should be cut 1-2 times per year and should be allowed to flower in summer/autumn before cutting. Hedgerows/scrub should be cut in early spring to provide fruit for birds overwinter.
- 5.28 Provision of fruiting scrub and hedgerows would encourage small birds into the cemetery which form the prey of sparrowhawks, a flagship species in Southwark. Retention of the majority of the woodland area in to south west, and of the overgrown hedgerows/scrub along the western boundary of the site would provide habitat for sparrowhawks which prefer to nest in woodland but will also use smaller patches including overgrown hedgerows.
- 5.29 In order to enhance the biodiversity value of the sports field, a target in the local BAP, the outgrown hawthorn hedge to the east, between the sports field and the tennis court could be cut back to encourage bushy growth, and continuity could be improved through additional native scrub planting in gaps. In addition, the mowing regime should be relaxed (as described above) either side of the hedge to allow a strip at least 1m wide either side of the hedge to develop as longer grassland habitat for wildlife.
- 5.30 Strips of longer grassland could also be allowed to develop adjacent to the hedges and scrub belts at the western and northern edge of the site, enabling colonisation by ground flora currently restricted to small areas of the cemetery such as bird's-foot trefoil, dog violet, meadow vetchling and buttercup which is one of the flagship species of open spaces in the local BAP. This grassland should also be cut no more than twice per year, and should be cut in spring and late autumn to allow flowering.

- 5.31 Where possible, standing and fallen dead wood should be retained, subject to health and safety requirements, and log piles should be created to benefit invertebrates. Where burial is proposed in an area where felling of trees is required, specific trees could be selected for ring barking to enable excavation while retaining standing dead wood for invertebrates and as bird perches. New trees could be planted around the woodland edge and dedicated/sponsored for revenue. Bird nesting boxes could also be installed on larger retained trees and buildings, and if lack of space limits new tree planting, these bird boxes could be sponsored.
- 5.32 There may also be opportunities for creating a wetland habitat within the cemetery which would enhance biodiversity and the amenity value of the site. An area of hard standing colonised by common reed adjacent to the basketball court may provide a potential location for a wetland scrape/reed bed, and this would also benefit from connectivity to the adjacent Railway Cutting Site of Metropolitan Interest. Habitat creation such as this would contribute to the London habitat action plans for standing water and reed beds.
- 5.33 Production of a cemetery conservation management plan, also recommended by English Heritage (2007), would aid effective integration of management/maintenance of the historic and functional aspects of the cemetery with nature/wildlife conservation. Use of interpretative signs around the cemetery in areas to be managed for wildlife would also aid public understanding and support of management regime changes.

Further surveys

- 5.34 A reptile survey is recommended if any major works (including for example extensive topsoil removal/excavation/ground works) are planned in the south western area of the cemetery, including in areas C, D and E. Results of the survey would be used to indicate likely impact of the proposed works on any reptiles present, and inform development of a mitigation strategy.
- 5.35 If any large semi-mature to mature trees are to be removed, or buildings with potential for bat are to be affected by works, a daytime inspection by a licensed bat worker would first be required to look for signs of bat and determine how favourable the structures were for use as a bat roost. Follow up night-time (dusk and dawn) emergence surveys may also be required in the summer period to confirm presence or likely absence. If a bat roost is to be affected, a licence would be required from Natural England.
- 5.36 If any major earthworks are proposed of areas larger than 0.5ha within 250m of the pond in the crematorium, a check should be made of the potential of pond to support great crested newt, and further surveys carried out to determine presence/likely absence if necessary.



KEY

Opportunities

Areas with no/few graves and minimal nature conservation constraints

Areas with dense graves and minimal nature conservation constraints

Potential for grassland, scrub, woodland and hedgerow management to benefit wildlife

Constraints

Potential reptile habitat

Secondary woodland (extension/buffer to One Tree Hill SNCI)

Current edge of woodland

Trees (not all shown on plan)

Hedgerow

Scrub/tree belt to be retained/managed for wildlife where possible

Japanese knotweed

All locations indicative and to be verified on site

Ordnance Survey Licence No. AL100036425

Drawn by	Check by	Date	Scale
MM	CB	Oct 2011	See bar

Camberwell New Cemetery

Opportunities and constraints

Catherine Bickmore Associates Ltd
ENVIRONMENTAL CONSULTANCY

LFG 5 Latone House, Leathermarket Street, London SE1 3HN
Tel: 020 73576700
E-mail: info@bickmoreassociates.co.uk
Website: www.bickmoreassociates.co.uk

Drawing number
645/03

Revision

Inset: Area D

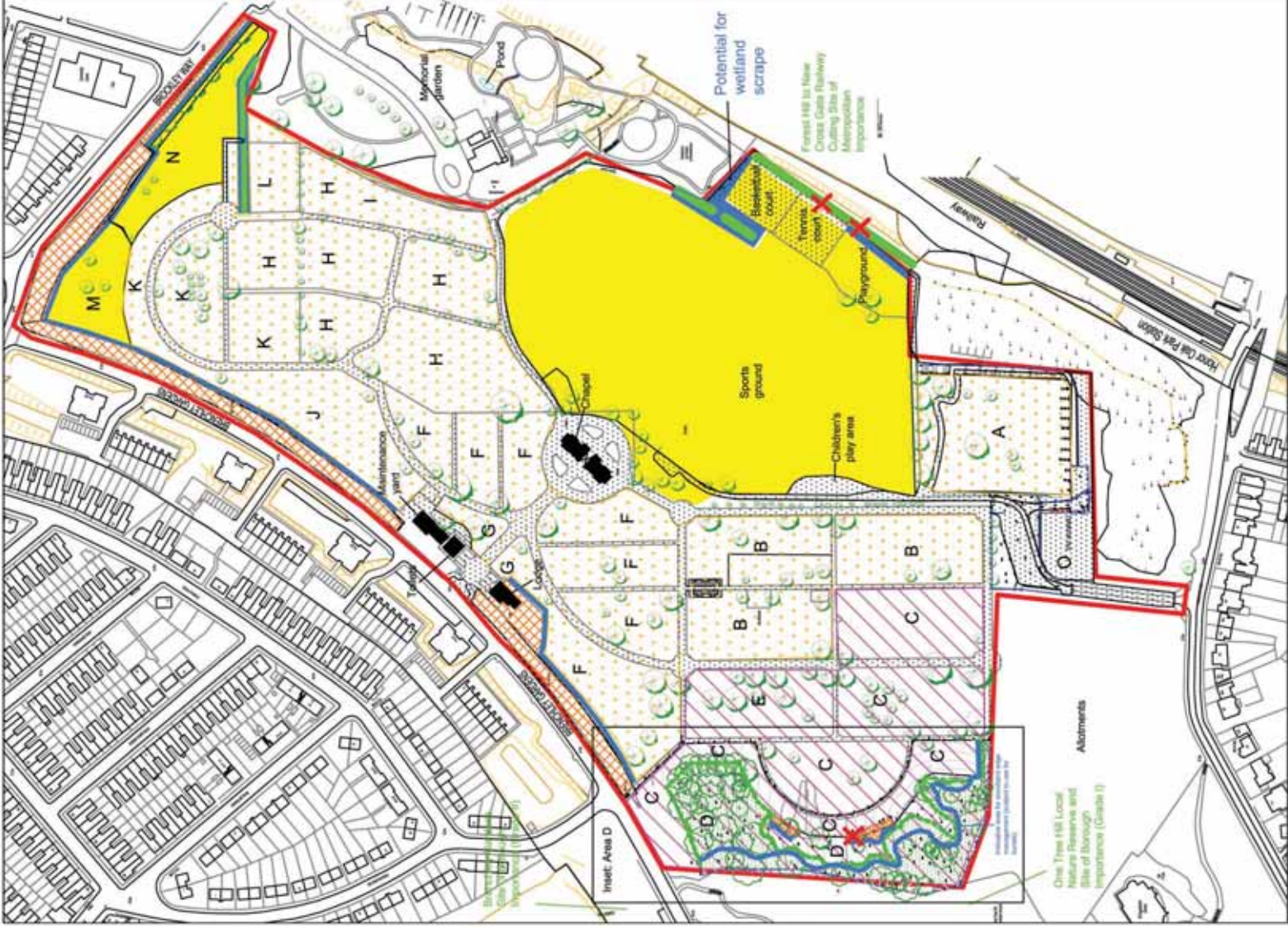

Indicative area for woodland edge management (subject to use for burials)

Inset: Area D

One Tree Hill Local Nature Reserve and Site of Borough Importance (Grade I)

Potential for wetland scrape







Forest Hill to New Cross Gate Railway Cutting Site of Metropolitan Importance

Admittance

REFERENCES

- ASW Ecology** (2011a) A bat assessment of selected trees at Camberwell Old Cemetery and Camberwell New Cemetery
- ASW Ecology** (2011b) A bat emergence survey of selected trees in areas F and H in Camberwell Old Cemetery
- BSBI** (2007) BSBI List of British & Irish Vascular Plants and Stoneworts
- Defra** (2011) *Biodiversity 2020: A strategy for England's wildlife and ecosystem services*. DEFRA
- Diocese of London** (2011) *In depth advice by topic: Biodiversity action plans/ Churchyards and wildlife/ Trees in churchyards* (<http://www.london.anglican.org/DACInDepthAdvice>; accessed 2nd November 2011).
- EC** (2011) *Our life insurance, our natural capital: An EU biodiversity strategy to 2020*
- English Heritage** (2007) *Paradise preserved: an introduction to the assessment, evaluation, conservation and management of historic cemeteries*
- Lewisham Council** (2011) *Unitary development plan* (<http://www2.lewisham.gov.uk/lbl/planning/udp/schedule2.html>; accessed 26th October 2011)
- London Biodiversity Partnership** (2011) *London's Biodiversity Action Plans* (<http://www.lbp.org.uk/londonhabspp.html>; accessed 18th October 2011)
- London Borough of Southwark** (2006-2010) *Biodiversity Action Plan: work for wildlife*
- London Borough of Southwark** (2011) *Proposals map* (http://maps.southwark.gov.uk/connect/southwark.jsp?info=Core_Strategy&mapcfg=CoreStrategy; accessed 26th October 2011)
- London Ecology Unit** (1989) *Nature conservation in Southwark: Ecology handbook 12*
- London Wildlife Trust** (2000) *Stag beetle: an advice note for its conservation in London*
- Nature Conservancy Council** (1990) *Handbook for Phase 1 habitat survey: a technique for environmental audit*.
- Old Maps** (2011) *Old Maps* (<http://www.old-maps.co.uk/maps.html>; accessed 17th October 2011).
- Southwark Council** (2011) *Core Strategy*
- Stace C.** (2010) *New flora of the British Isles, 3rd ed.* Cambridge University Press, Cambridge
- Greater London Authority** (2011) *The London Plan: Spatial development strategy for Greater London*
- UK Biodiversity Partnership** (2007) *Conserving biodiversity – the UK approach*. DEFRA

APPENDIX I: PHOTOSHEET – NEW CEMETERY

	
<p>P1: Dense woodland with ivy understorey (Area D)</p>	<p>P2: Improved amenity grassland adjacent to woodland (Area D)</p>
	
<p>P3: Open wooded area (northern part of Area D) behind kerb-set memorials in Area C</p>	<p>P4: Poor semi-improved, tall, rough grassland with scattered monuments and graves (Area E)</p>
	
<p>P5: Poor semi-improved grassland with scattered monuments (eastern bank of Area C)</p>	<p>P6: Northern part of closely maintained amenity grassland sports field (adjacent to Area H)</p>



P7: Outgrown hedgerow with gaps at eastern edge of sports field



P8: Amenity grassland slope in northern part of Area M



P9: Scattered graves within poor semi-improved grassland in Area N



P10: Improved amenity grassland with headstones (Area H)



P11: Poor semi-improved grassland with kerb-set memorials (Area K)



P12: Recently cut poor semi-improved grassland in Area F, and chapel

APPENDIX II: SPECIES LIST

Common name	Scientific name
Annual meadowgrass	<i>Poa annua</i>
Ash	<i>Fraxinus excelsior</i>
Autumn hawkbit	<i>Leontodon autumnalis</i>
Birch	<i>Betula sp.</i>
Black horehound	<i>Ballota nigra</i>
Bramble	<i>Rubus fruticosus agg.</i>
Broad-leaved dock	<i>Rumex obtusifolius</i>
Buddleia	<i>Buddleja davidii</i>
Cherry	<i>Prunus sp.</i>
Cleavers	<i>Galium aparine</i>
Cock's-foot	<i>Dactylis glomerata</i>
Comfrey	<i>Symphytum sp.</i>
Common bird's-foot trefoil	<i>Lotus corniculatus</i>
Common dog violet	<i>Viola riviniana</i>
Common field speedwell	<i>Veronica persica</i>
Common mallow	<i>Malva sylvestris</i>
Common reed	<i>Phragmites australis</i>
Common vetch	<i>Vicia sativa</i>
Couch grass	<i>Elytrigia repens</i>
Cow parsley	<i>Anthriscus sylvestris</i>
Creeping buttercup	<i>Ranunculus repens</i>
Creeping cinquefoil	<i>Potentilla reptans</i>
Creeping thistle	<i>Cirsium arvense</i>
Cypress	<i>Cupressus/Chamaecyparis sp.</i>
Daisy	<i>Bellis perennis</i>
Dog rose	<i>Rosa canina</i>
Elder	<i>Sambucus nigra</i>
Elm	<i>Ulmus sp.</i>
English oak	<i>Quercus robur</i>
False acacia	<i>Robinia pseudoacacia</i>
False oat-grass	<i>Arrhenatherum elatius</i>
Firethorn	<i>Pyracantha sp.</i>
Garden privet	<i>Ligustrum ovalifolium</i>
Great willowherb	<i>Epilobium hirsutum</i>
Greater plantain	<i>Plantago major</i>
Ground ivy	<i>Glechoma hederacea</i>

Hairy tare	<i>Vicia hirsuta</i>
Hawkweed oxtongue	<i>Picris hieracioides</i>
Hawthorn	<i>Crataegus monogyna (agg)</i>
Hedgerow crane's-bill	<i>Geranium pyrenaicum</i>
Herb Robert	<i>Geranium robertianum</i>
Hogweed	<i>Heracleum sphondylium</i>
Holly	<i>Ilex aquifolium</i>
Horse chestnut	<i>Acer pseudoplatanus</i>
Ivy	<i>Hedera helix</i>
Japanese knotweed	<i>Fallopia japonica</i>
Large bindweed	<i>Calystegia silvatica</i>
Lime	<i>Tilia sp.</i>
Meadow buttercup	<i>Ranunculus acris</i>
Meadow vetchling	<i>Lathyrus pratensis</i>
Nettle	<i>Urtica dioica</i>
Oak	<i>Quercus robur</i>
Perennial ryegrass	<i>Lolium perenne</i>
Plane	<i>Platanus sp.</i>
Poplar	<i>Populus sp.</i>
Procumbent yellow sorrel	<i>Oxalis corniculata</i>
Redshank	<i>Persicaria maculosa</i>
Rhododendron	<i>Rhododendron sp.</i>
Ribwort plantain	<i>Plantago lanceolata</i>
Rose (ornamental)	<i>Rosa sp.</i>
Scarlet pimpernel	<i>Anagallis arvensis subsp. arvensis</i>
Snowberry	<i>Symphoricarpos albus</i>
Spear thistle	<i>Cirsium vulgare</i>
Spindle (introduced)	<i>Euonymous sp.</i>
Stonecrop	<i>Sedum sp.</i>
Sycamore	<i>Acer pseudoplatanus</i>
Upright hedge parsley	<i>Torilis japonica</i>
White clover	<i>Trifolium repens</i>
Whitebeam	<i>Sorbus sp.</i>
Wood avens	<i>Geum urbanum</i>
Wood dock	<i>Rumex sanguineus</i>
Yew	<i>Taxus baccata</i>

APPENDIX III: SUMMARY OF LEGISLATION

Note: this summary does not represent a legal opinion

Great crested newt and bat

Great crested newts and all British bat species are fully protected by the Wildlife & Countryside Act 1981 (as amended) and by The conservation of habitats and species regulations 2010 ('Habitat Regulations'). In summary, the legislation combined makes it an offence to:

- Deliberately, intentionally or recklessly capture/take, injure or kill a great crested newt or bat, or take or destroy great crested newt eggs;
- possess or control any live or dead specimen or anything derived from a great crested newt or bat;
- damage or destroy a breeding site or resting place or intentionally or recklessly obstruct access to any structure used for shelter or protection;
- intentionally or recklessly disturb a great crested newt or bat while it is occupying a structure or place which it uses for that purpose, or deliberately disturb any great crested newt or bat in a manner likely to impair its ability to survive, hibernate, migrate, breed or reproduce or to rear or nurture their young, or to significantly affect the local distribution or abundance of the species.

Works that would result in any of the activities listed above including for example destruction of habitat may be undertaken subject to the granting of a European Protected Species (EPS) licence under Regulation 53 of the Habitats Regulations, and issued by Natural England. The licence must be accompanied by a method statement, and a reasoned statement of application showing how the proposals meet the three tests. The method statement should address how an equivalent population of great crested newt/bat will be maintained as a result of the activities.

Reptile

All reptiles are protected under the wildlife legislation in the Wildlife and Countryside Act 1981 (as amended) which protects these species against intentional killing and injuring (under part of Section 9(1) and Section 9(5)).

Badger

Badgers are protected by the Protection of Badgers Act 1992. The Act makes it an offence to:

- Wilfully kill, injure, take, possess or cruelly ill-treat a badger;
- Intentionally or recklessly interfere with a sett.

Sett interference includes the disturbance of badgers whilst occupying their sett and the damage, destruction or blocking of a sett. Guidance on what development related activities are considered likely to cause disturbance is available (Natural England 2007).

A badger sett is defined within the legislation as "any structure or place, which shows signs indicating current use by a badger".

Breeding bird

Subject to the provisions of part 1 of the Wildlife and Countryside Act 1981 (as amended) it is an offence to intentionally:

- a) kill, injure or take any wild bird
- b) take damage or destroy the nest of any wild bird
- c) take or destroy an egg of any wild bird

Japanese knotweed

Japanese knotweed is listed on Schedule 9 of the Wildlife and Countryside Act 1981. It is an offence to "plant or otherwise cause to grow in the wild" any plant on the schedule. This has implications for control methods and disposal e.g. flailing can cause further spread.

Vegetative material and contaminated soil is classed as 'controlled waste' under the section 43 of Environmental Protection Act, 1990, and therefore must be disposed of at a licensed landfill site in accordance with the Environmental Protection (Duty of Care) Regulations, 1991 (as amended 2003).

Appendix 2.3

Tree Preservation Order

(and) standards.

Town & Country Planning Act 1990

Form DD2

TP/ ~~2567-112~~
23411-F

Confirmation of Tree Preservation Order



Southwark Council

Decision Under Delegated Authority

1. Site: Camberwell Old Cemetery (bounded by Wood Vale Forest Hill Rd and Underhill Rd)

2. Owners (where known) LB of Southwark

3. The Director of Legal services has served on the owners/occupiers/affected parties notice of the making of a Tree Preservation Order under section 198, and a direction under section 201, of the Town and Country Planning Act 1990 in respect of the tree (trees) shown on drawing No. TP/23411-F attached hereto. The original drawing forms part of the TPO made on 4.11.93 (Leg/TPO No. 23411).

4. Considerations (objections/representations/other relevant matters)

No objections

5. RECOMMENDATION:

- Either 1. Confirm this Order as permanent because
 - no objections have been received and no modifications are proposed/
 - ~~-such objections and representations as have been received are not con-~~
 - sidered sufficient to lead to amendment or non-confirmation
- or 2. Confirm this Order as permanent with the following modification(s)
- or ~~3. This Order is not to be confirmed as permanent because~~

Checked by Tree Officer:

Date: 6/4/95

Signature: [Handwritten Signature]

Agreed by Manager:

Date: 7/4/95

Signature: [Handwritten Signature]

The above TPO is hereby confirmed/
confirmed with modifications/ not confirmed:

Date: 7/4/95

Signature: [Handwritten Signature]

Borough Planner/Controller of Development Control

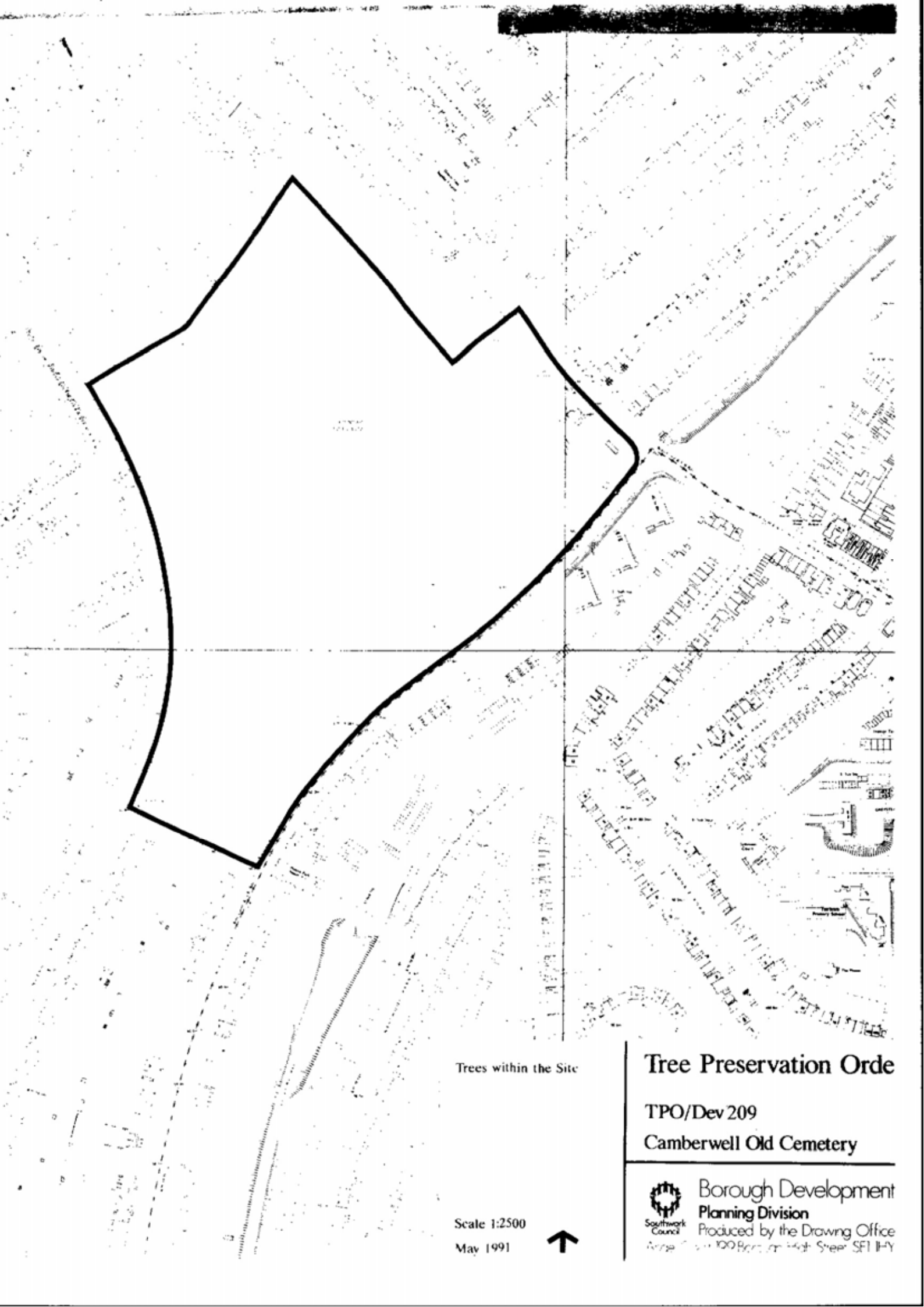

Trees within the Site

Tree Preservation Order

TPO/Dev 209

Camberwell Old Cemetery

Scale 1:2500

May 1991



Southwark Council

Borough Development
Planning Division

Produced by the Drawing Office
100 Borough Road, London SE1 1JY

Appendix 2.4
Consultation Report:
Executive Summary and Survey Results

LB Southwark Cemeteries Consultation Report 2011



prepared by Alexandra Robb, Community Consultant

**Southwark Council, Environment and Leisure Department,
Public Realm Division, Parks and Open Spaces,
PO Box 64529,
London,
SE1P5LX**

1. Executive summary

- 1.1 Southwark Council is undertaking a major review of its burial provision, due to the borough's cemeteries being nearly full. There is limited burial space available in the borough's three existing cemeteries at Camberwell Old Cemetery, Camberwell New Cemetery and Nunhead Cemetery. Future options have to be considered if Southwark Council is to continue to offer a burial service to residents.
- 1.2 From 4th July to 30th September 2011, Southwark Council carried out a consultation with residents and stakeholders.
- 1.3 Landscape architects were commissioned to assess the situation in Southwark's three Cemeteries and draw up a number of options for the future. These options provided the basis for the consultation.
- 1.4 The consultation has been a valuable exercise in harnessing the views of both Southwark residents and other stakeholders aboutg the future of burial services in the borough.
- 1.5 There have been 942 responses to the questionnaire with people being open and vocal about a highly sensitive subject. The responses have been of high quality with over 1,000 individual comments, which have been used to help inform this report. (See Appendix 7 for full list of comments).
- 1.6 Over 170 people attended consultation meetings in the borough.
- 1.7 The results of the questionnaire have indicated that 77% of residents will require cremation in the future, compared with 22% requiring burial. These statistics vary somewhat from UK National averages of 70% and 30% respectively, suggesting a slightly higher percentage than average for those requiring cremation. Southwark Cemetery & Crematorium service is currently performing burials for around 30% of service users.
- 1.8 It is hard to ascertain whether these results imply a shift in people's perceived future needs or they are influenced by the demographic responding to the survey (a significant number of responses came from residents living in the immediate area of Honor Oak Recreation ground and Camberwell New Cemetery).
- 1.9 However what is clear from the results is that there is still a significant number of Southwark residents who will require burial in the future.
- 1.10 People's reasons for their choice of burial or cremation were varied.
- 1.11 A key theme with respondents who chose cremation is the lack of space in the borough to perform burials. Many were concerned with the potential for losing valuable green space, feeling that in today's society open space for recreation and enjoyment was vital to the health of a population for whom obesity and ill health is on the increase. Strong feelings were expressed by many on the subject, with the comment that 'Land is for the Living' featuring on several forms submitted.
- 1.12 Many of those requiring burial emphasised their emotional attachment to the borough and felt strongly about being buried in the place in which they had lived all their lives. Many have several generations of family buried in Southwark and felt it important to be buried close to other family members.

Those who have family members buried in the borough value being able to visit them without having too far to travel.

- 1.13 On the question of whether it was important for Southwark to continue to provide burial services for its residents, opinions were fairly evenly divided. Family and cultural traditions were prominent reasons given for those who consider burial provision to be important.
- 1.14 Of those who did not consider it important for Southwark to provide burial, most cited the reasons mentioned in 1.6 there simply isn't the space in the borough and it is unacceptable to use space that currently exists for recreation.
- 1.15 Some respondents who did not consider burial provision to be important qualified this by stating that they were in favour of burial outside the borough and felt that solutions could be reached, possible in partnership with other Local Authorities, to provide such a service. However, there was also concern that if burial was moved out of the Borough, barriers such as economic disadvantage and lack of mobility would restrict people's ability to visit loved ones graves.
- 1.16 Respondents were asked to rate eight possible options for the future of burial in the Borough.
- 1.17 The most popular option was the **reuse of common graves**. This was considered the most sustainable long term option, having the least impact on both the Borough's open spaces and bereaved relatives.
- 1.18 The next most popular option was the **reuse of private graves**. For both options it was felt that all efforts would need to be made to contact living family members. It was suggested that records should be kept of reused graves and alternative memorials to the deceased created.
- 1.19 **The use of burial chambers** was cited as the third most popular option. This received support because it was felt they provide opportunity to maximise the use of available space. Some respondents were concerned about the potential for vandalism and others around how remains might ultimately be disposed of. This option would require a major cultural adjustment but could be explored as part of a package of options.
- 1.20 The fourth most popular option was **working with other local authorities to source shared land for new cemeteries**. There was some support for this option, which would relieve pressure on Southwark to find space. However, again some people were concerned about having to visit graves outside the borough. Comments were made on the growing interest in woodland burials, as being sustainable and environmentally friendly which would have to be undertaken outside the Borough and could be included in a package of options offered.
- 1.21 **Finding a burial site outside Southwark** was the fifth option chosen. This did not receive a great deal of support, for the reasons expressed above regarding accessibility.
- 1.22 **Share a cemetery elsewhere or buy graves from a private supplier**. This was not a popular option. Buying graves from a private supplier was considered to be problematic as there would be no guarantee as to the sustainability for the service that might be offered, making it clear that people

would prefer to have confidence in their local authority to provide burial services.

- 1.23 One of the least favourite options was **to stop burying in Southwark**. This received very little support. Even those with a preference for cremation were still in favour of people having burial as a choice.
- 1.24 Consequently whilst over 50% of respondents did not consider Southwark burial provision to be important the option to stop burying was not rated highly.
- 1.25 **Use of some or all of Honor Oak Recreation Ground for burials** was the least favoured option and the one that attracted the most comment.
- 1.26 A total of 214 comments were received in support of not using Honor Oak Recreation ground for burials. The key reasons for not using the site included:
- Consideration for it's current use for recreation (see Chapter 8 for details of a usage survey undertaken)
 - Lack of available open space in the Borough
 - Concerns that the Council would choose this as the cheapest option, without consideration of the impact its loss would have on the young people of the local area, who value it for recreation.
- 1.27 There appears to be a groundswell of local opinion opposing the use of Honor Oak Recreation Ground for future burial. There is an active and vocal Friends group who have previously gathered over 2000 signatures for an online petition opposing its use. A campaign by the group to encouraged supporters to complete the questionnaire may well have had an impact on the results.
- 1.28 There were also a relatively small, but significant number of responses that indicated people would be in favour of using some or all of Honor Oak Recreation Ground. It was felt that the land was purchased for this purpose and should be used as such. This was a predominant response from church / faith leaders. Some respondents felt that Honor Oak Park was an underused resource.
- 1.29 The usage survey of Honor Oak Recreation ground during April, May and September provides a snapshot of its current use. During the summer months it does appear to enjoy regular use by the local community. The playground is frequented by families with young children and many use the space as a pedestrian through route. During the football season the pitches are utilised for training by junior football clubs.
- 1.30 Using the data collected it has been possible to extrapolate that the space would expect to attract nearly 280,000 visitors per year. However this figure is not significantly higher than parks in Southwark that are less than half its size. Chapter 9 details this analysis.
- 1.31 It is clear from the consultation that the subject of future burial and bereavement services are something that Southwark residents feel strongly about. The Borough needs to be able to offer a package of options that are acceptable to residents and it is intended that this consultation will help inform this. Many respondents commented on the need for people to be fully informed about their options for burial or cremation and the long term implications of their choices. It may be desirable in the future to affect a programme of public information that does this.

Appendix 4.1

Lawn Regulations and Leaflet

Southwark Cemetery Regulations

Lawn type purchase as from 17.10.2011

Camberwell Old Cemetery

These regulations need to be agreed to prior to burial.

- **Lawn type Grave** : headstone only permitted. **Headstones must not be more than 3ft high and 2ft 6inc wide.** All headstones must be cut from one solid block, and fitted to a shoe beneath the bearer. A Vase plate may be placed in front of the memorial maximum size **9" x 2'6" x 2"**, **NOT EXCEEDING ONTO THE LAWN.** All memorials must have the grave number inscribed thereon. Only natural stone is permitted.

GARDENS AREAS ARE NOT PERMITTED. Only fresh cut flowers may be placed in vases supplied within the memorial vase plate. Any items found to be placed on the lawn area in front the memorial will be removed and disposed off immediately.

- Iron railings, chains, wooden fences, plastic fences, paving stones, stone chippings, artificial flowers, trinkets, wind chimes, balloons or glass in any form are **not permitted** to be placed around or upon grave sites.

- Hewing or dressing of memorials, trees or benches within the cemetery is not permitted.



I being the purchaser of the Exclusive Rights of Burial do agree to abide by the cemetery regulations above and understand that any object found upon the lawn area will be disposed off without notice.

Signed Dated.....

Printed Name & Address.....

.....

.....

.....

Southwark Cemetery Regulations

Lawn type purchase as from 17.10.2011

Camberwell New Cemetery

These regulations need to be agreed to prior to burial.

- **Lawn type Grave** : headstone only permitted. **Headstones must not be more than 3ft high and 2ft 6inc wide.** All headstones must be cut from one solid block, anchored to a base (2'6 x 12" x 3") and secured to the bearer supplied. All memorials must have the grave number inscribed thereon. Only natural stone is permitted.

GARDENS AREAS ARE NOT PERMITTED. Only fresh cut flowers may be placed in vases supplied within the base of your memorial. Any items found to be placed on the lawn area in front the memorial will be removed and disposed off immediately.

- Iron railings, chains, wooden fences, plastic fences, paving stones, stone chippings, artificial flowers, trinkets, wind chimes, balloons or glass in any form are **not permitted** to be placed around or upon grave sites.

- Hewing or dressing of memorials, trees or benches within the cemetery is not permitted.



I being the purchaser of the Exclusive Rights of Burial do agree to abide by the cemetery regulations above and understand that any object found upon the lawn area will be disposed off without notice.

Signed Dated.....

Printed Name & Address.....

.....

.....

.....

Site opening and closing times

Summer 1 April to 30 September

Monday to Saturday
8.30am to 7pm

Sunday and Bank Holidays
10am to 7pm

Winter 1 October to 31 March

Monday to Saturday
8.30am to 5pm

Sunday and Bank Holidays
10am to 5pm

For more information about cemeteries and burial services in Southwark please contact our cemetery office at

Camberwell New Cemetery
Branchley Gardens
Forest Hill
SE23 3RD

Open Monday to Friday (excluding Bank Holidays)
9am to 4.30pm

020 7525 5600
www.southwark.gov.uk/cemeteries

Lawn graves, memorials and landscaping



Lawn graves, memorials and landscaping

Our aim is to ensure our cemeteries are welcoming, safe and well maintained and we want our cemeteries to provide a peaceful and attractive environment for you and your family to visit. We are committed to providing a sustainable burial service for local residents which includes the landscaping of graves and monitoring of memorials.

The London Borough of Southwark has three cemeteries: Camberwell Old Cemetery, Camberwell New Cemetery and Nunhead Cemetery. Nunhead Cemetery has achieved a Green Flag Award. New burial spaces are currently only available in Camberwell New Cemetery and Camberwell Old Cemetery. They are lawn type burial sites.

Purchase of new grave spaces

New grave spaces can be purchased for immediate burials or for the interment of ashes. Details of our fees and charges can be found on our website.

It is important that you and your family as well as your funeral directors are clear about the type of site they are buying and aware of the regulations relating to the placing of memorials and tributes such as flowers on the sites as follows:

- All new graves sites purchased are located in either Camberwell New Cemetery and Camberwell Old Cemetery and are laid upon lawn type burial sites. This means that a headstone and base is permitted upon the beam* or shingle bearer where provided (pictured right).



*A beam is a low (10-15 cm) raised concrete slab at the head of the grave. The graves themselves are covered with grass. The beam is where the headstone and base will be positioned and where families can place floral tributes without interfering with the mowing.



- Full memorial sites or extension of kerbing to an existing memorial are not permitted in these areas.
- Garden areas are not permitted on the lawn areas in front of the bearers. Fresh cut flowers or potted plants may be laid in the tribute area attached to your memorial or on the beam or shingle bearer supplied. Any items found to be placed on the lawn once turf has been reinstated following burial will be removed and disposed off without notice. Turfing usually takes place within three to six months.

- Floral tributes and wreaths are removed by cemetery staff 21 days after burial.

Dimensions for lawn type memorials:

A headstone only is permitted.

Headstones must not be more than 3' high x 2' wide x 3" thickness. All headstones must be secured to a base, 2'6" x 12" x 3", and fitted to the bearer where supplied or fitted into a shoe below a shingle bed.

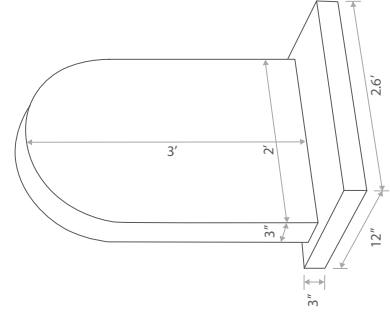

If you would like more information about Accredited Stone or memorial masons please contact the cemetery office.

Memorials are the responsibility of the grave owner but memorial safety and associated inspections are undertaken by Southwark Council.

Appendix 5.1

Parks and Open Spaces -Existing Roles

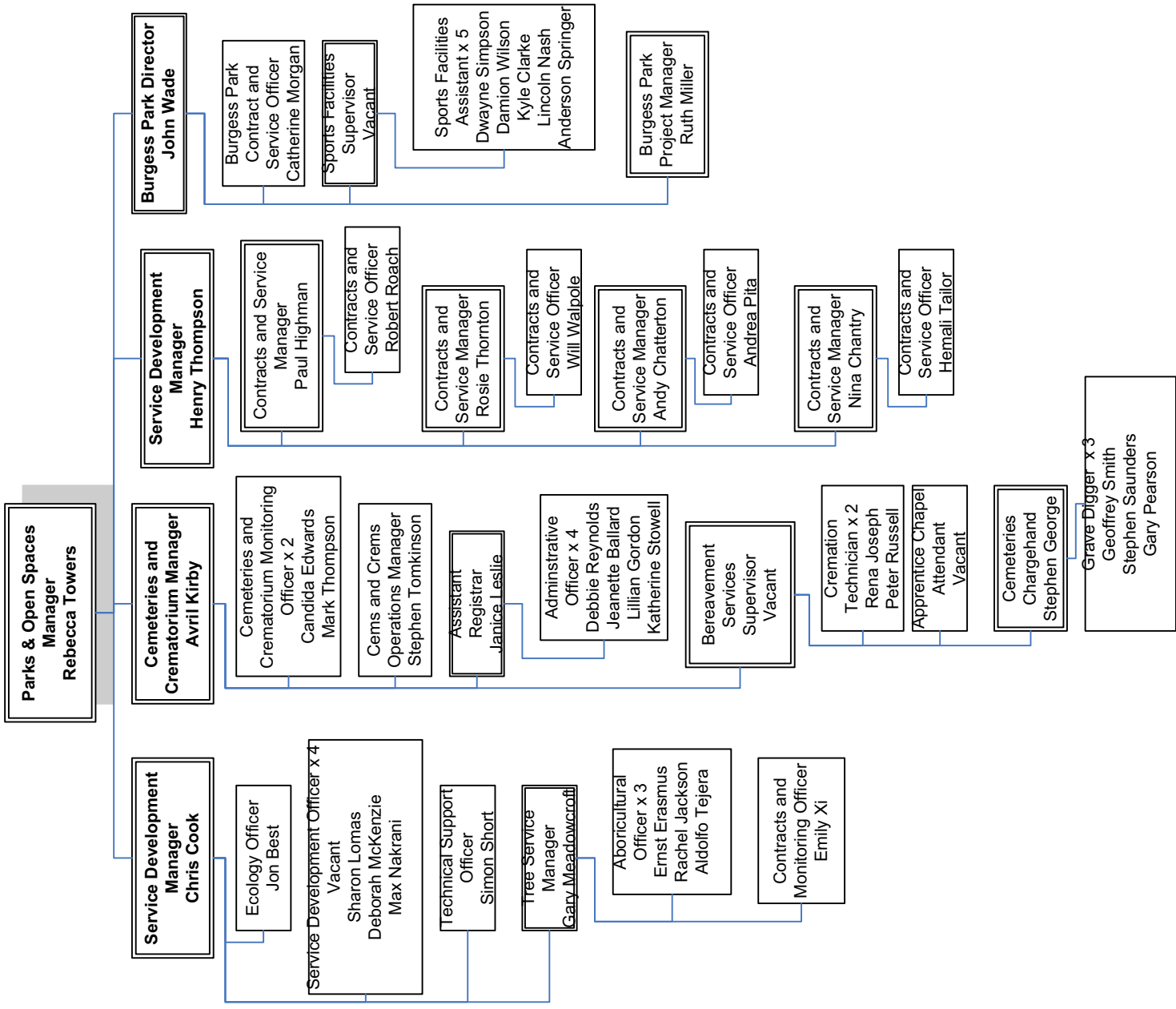

Appendix 5.2

Heritage Memorial Code

DRAFT Heritage Memorial Code (Regulations)

To be read with Regulations applicable to Camberwell Old Cemetery and Camberwell New Cemetery

1. These Regulations shall apply to all areas designated as being Heritage Memorial Areas within Camberwell Old and Camberwell New Cemetery and are to be read alongside and in conjunction with the 'Cemetery Fees and Regulations' adopted ###/##/###/ by the Southwark Council.

2. Subject to paragraph 1, all new memorials within a *Heritage Memorial Area* within ### Cemetery must be authorized by officer of Southwark Council. That authorization shall follow only where the following stipulations are met:

(a) at least ## months have elapsed since the most recent of the deaths being commemorated;

(b) the form of the memorial is either :

- i a vertical headstone, (**monolithic headstone**) or
- ii a vertical headstone on a horizontal stone base (**lawn memorial**) , or
- iii a **traditional kerb set** (on designated graves only),
- iv a simple timber cross;

(c) the memorial is adequately secured in the ground to NAMM approved standards so as to ensure that it is stable;

(d) in the case of any or all stone memorials,

- i it is of natural stone (either sandstone, limestone, granite not darker than Rustenberg grey, or slate), and
- ii it does not have a highly polished reflective finish;

(e) in the case of a memorial consisting of a vertical **monolithic headstone**, without a horizontal stone base where,

- i the height of the vertical stone above ground level is between 500 mm (1ft 8 in) and 1200 mm (4 ft);
- ii the width if between 500 mm (1ft 8 in) and 900 mm (3 ft);
- iii its thickness is, in the case of a slate memorial, between 40 mm (1 1/2 in) and 150 mm (6 in) or, in any other case, between 75 mm (3 in) and 150 mm (6 in);
- iv any foundation slab is located so that its upper surface is either flush with the surrounding ground level or at least 300 mm (12 in) beneath it;

(f) in the case of a memorial consisting of a vertical **lawn memorial** headstone on a horizontal slab where,

- i the base is an integral part of the design and no more than 300 deep x 1370mm wide (12"x2'6")
- ii where it incorporates a receptacle for a flower vase, there is provision for no more than one such vase;
- iii where it incorporates a receptacle for a flower vase, the base does not project more than 200 mm (8 in) beyond the face of the vertical stone; and
- iv in any other case, it does not project more than 150 mm (6 in);
- v with a head plate of no more than 90mm high x 600mm wide x 75mm thick (3' x 2' x 3")

(g) in the case of a **traditional kerbset** memorials consisting of a set of kerbs, a head plate with or without a horizontal slab,

- i where on a designated graves within the cemetery as directed by the Cemeteries and Crematorium Manager and where
- ii it is no more than 750 mm (2'6" ft) wide and 1800 mm (6 ft) long, in total and
- iii the upper surface of kerb or stone shall be no more than 150mm (6") above the surrounding ground;
- iv and the height of the vertical stone (headplate) above ground level is between 500 mm (1ft 8 in) and 1200 mm (4 ft); and,
- v the width of the vertical stone (headplate) is between 500 mm (1ft 8 in) and 900 mm (3 ft);

(h) the inscription on the memorial contains at least:

- i the name of the deceased;
- ii the date of his or her death;
- iii the date of birth or the age at death,
- iv the plot and section number

(i) any factual material in the inscription must be accurate and:

- i the inscription or artwork must be incised into the stone and, if painted, no more than one colour shall be used; and
- ii the memorial shall contain no advertisement or trademark other than the name or mark of the mason which, if included, shall be at the base of the side or rear face of the stone and no more than 13 mm (1/2 in) high.

(j) where a plot occupies an older private plot where the rights have been extinguished under the provisions of the Greater London (General Powers) Act 1976 (and there is a requirement to include an inscription to any person previously interred within that grave) then an inscription on the reverse of any new or restored memorial shall include, in respect of the person or persons previously interred, at least:

- i the name(s) of the deceased;
- ii the date(s) of his or her death;
- iii the date(s) of birth or the age at death,
- iv the plot and section number

3. No other memorial shall only be introduced without the authority of the Officer appointed by the burial authority.

4. Notwithstanding compliance with paragraph 2, the Officer shall not approve a proposed memorial if he or she considers that it is:

- i likely to be controversial for some reason;
- ii is in any way inappropriate,

and in considering whether to approve a proposed memorial the officer shall have regard to the current version of the Conservation Management Plan for the cemetery.

5. "Officer" means the Cemeteries and Crematorium Manager of Southwark Council or his or her authorized representative.

By order of

Cemeteries and Crematorium Manager

Southwark Council

Date

Appendix 5.3 Memorial Panel

HERITAGE PANEL PROCESS: MEMORIAL ASSESSMENT CATEGORIES AND CRITERIA

HERITAGE PANEL PROCESS: MEMORIAL ASSESSMENT CATEGORIES AND CRITERIA				
Main Category	Sub-Cat	Primary Criteria	Secondary Criteria	Options
1	A1	Listed memorial or funerary monument	Re inscription of memorial associated with re-use/reclamation of grave would <i>not</i> be appropriate Restoration/renovation costs justified.	Restore without associated re-use/reclamation of grave
1	A2	Listed memorial or funerary monument	Re inscription of memorial associated with re-use/reclamation of grave would <i>not</i> be appropriate Restoration/renovation costs <i>not</i> justified at present.	Stabilise keep under review
1	B1	Memorial to a person of very significant local historical interest or of clear national interest (e.g. persons in the Oxford Dictionary of National Biography)	Re inscription of memorial associated with re-use/reclamation of grave would <i>not</i> be appropriate and Restoration/renovation costs justified using restoration funds.	Restore without associated re-use/reclamation of grave
1	B2	Memorial to a person of very significant local historical interest or of clear national interest (eh persons in the Oxford Dictionary of National Biography)	Re inscription of memorial associated with re-use/reclamation of grave would <i>not</i> be appropriate But Restoration/renovation costs <i>not</i> justified at present.	Stabilise keep under review
1	C1	Other distinctive memorials not Listed but of local interest i being the work of a noted architect, sculptor/ designer; or ii possessing special qualities of design and execution; or iii part of a special group, or playing a key visual role in the landscape; or iv of interest in their symbolism or iconography; or v with inscriptions of exceptional interest; vi of interest because of their materials or construction or where these reflect regional specialities; and In reasonable condition	Re inscription of memorial associated with re-use/ reclamation of inscription and re inscription or by reversal and re-inscription) and Restoration of memorial is viable funded from costs recharged to new custodian	Restore and make available to new custodian ready for re inscription.

1	C2	As C1 above and in reasonable condition	Re inscription of memorial associated with re-use/reclamation of grave not possible/appropriate without loss of integrity. but viable to stabilise and restore using restoration funds Not viable to restore using restoration funds	Restore without associated re-use/ reclamation of grave
1	D	As C1 above but in poor condition		Stabilise only and keep under review. Re categorise to Category 4 where condition/stability deteriorates
2	E	Memorial <i>not</i> of high heritage significance, but in good condition and with inscription to at least one person legible	Re inscription of memorial associated with re-use/reclamation of grave would be possible and Restoration of memorial is viable funded from costs recharged to new custodian	Restore and make available to new custodian ready for re inscription.
2	F	As E	Re inscription of memorial associated with re-use/reclamation of grave would be possible but Restoration of memorial would <i>not</i> be viable funded from costs recharged to new custodian	Stabilise leave insitu, or If re-use/reclamation of grave is paramount then remove and potentially re use components Replace with new memorial in accord with heritage memorial code as appropriate
2	G	As E	Reversal and re-inscription of memorial associated with re-use/reclamation of grave <i>not</i> possible due to design.	Stabilise leave insitu, or If re-use/reclamation of grave is paramount then remove. Replace with new memorial in accord with heritage memorial code as appropriate
3	H	Memorial <i>not</i> of high heritage significance but stable and in reasonable condition. with no legible inscription or inscription in poor condition and incapable of being restored.	Re inscription of memorial associated with re-use/reclamation of grave would be possible and Restoration of memorial is viable funded from costs recharged to new custodian	Restore and make available to new custodian ready for re inscription.
4	I	Memorial not of high heritage significance and either unstable and/or in dilapidated condition.	Does not merit Beyond repair at reasonable cost	If grave is purchased and grave re-used or subject to reclamation then new memorial erected in accord with heritage memorial code.

Appendix 6.1
Cemetery Strategy : Executive Summary and Figures

Southwark Council

Cemetery Strategy



April 2012

This Strategy has been co-ordinated and prepared by Harrison Design Development Ltd on behalf of Southwark Council with inputs from Julie Rugg of Cemetery Research Group (University of York) and Ron Dunn of Dunn and Co.

Contents

- Executive Summary
- Location Plan
- 1.0 Introduction, Scope
- 2.0 Background
- 3.0 The Cemeteries
- 4.0 Consultation
- 5.0 The Legal Framework
- 6.0 Cemetery Strategy – Short and Medium Term
- 7.0 Cemetery Strategy – Long Term
- 8.0 Risk, Costs
- 9.0 Next Steps

Figures

Figure 1 Historic Plot Overlay Camberwell Old	048.02.09
Figure 2 Historic Square Overlay Camberwell New	048-02.09A
Figure 3 Short and Medium Term Options Camberwell Old	048-02.05
Figure 4 Short and Medium Term Options Camberwell New	048-02.06
Figure 5 Short and Long Term Options Camberwell Old	048-02.07
Figure 6 Short and Long Options Camberwell New	048-02.08

Appendices

Appendix 1	Historic Layout Plans
Appendix 2	Greater London General Powers Act Section 9
Appendix 3	Sample Burial Data Camberwell New
Appendix 4	Short and Medium Term Cost Illustrations
Appendix 5	Short and Medium Term Options - Illustrations
Appendix 6	Consultation Options - Illustrations

Executive Summary

This Cemetery Strategy for Southwark Council seeks to address the chronic shortage of burial space in the borough. The Strategy focusses on practical options for burial within the current cemetery areas within Southwark but also takes account of potential options for burial outside of those areas.

This Strategy is informed by earlier studies commissioned by Southwark in respect of the cemeteries and also by the *Audit of London Burial Provision* (commissioned by the Greater London Authority and undertaken by the Cemetery Research Group, University of York in March 2011). The Audit revealed that in many London boroughs supply of burial space is becoming critical. In April 2011 a number of options to provide burial space were highlighted in a report to Southwark Council cabinet. The cabinet approved that these options should be pursued. Over the Summer of 2011 a programme of public consultation was carried out seeking views on future burial provision in the Borough.

This Strategy considers a range of options addressing short, medium and long term provision of burial space, and is focussed on the Camberwell Old Cemetery and Camberwell New Cemetery.

The 'immediate' options presented to cabinet have been considered and are being developed alongside and as part of the 'short term' options proposed in this report. These include recently decontaminated land at the old Honor Oak Nursery site, as well as an area of old public (or common) graves in the south of Camberwell Old which requires to be 'topped up' with soil to enable it to receive burials. A wooded area of virgin ground in the west of Camberwell New is similarly proposed to be taken forward. In addition further burial is proposed for the remainder of the old nursery site, and for a second area of public graves that had previously been 'topped up' in the north of Camberwell Old. Specific capacity for Muslim burials is also proposed.

'Medium Term' options from 2022 onward include the re-use of unmarked public graves older than 75 years old (and in most instances nearly 95 years old) in consecrated parts of Camberwell Old and Camberwell New. This would be subject to

church permission (a 'Faculty') and any remains encountered would be re-interred and recorded in a consecrated grave adjacent. This has been approach has been successful elsewhere, notably in the City of London Cemetery. In addition, in the medium term, it is proposed that rights to private graves older than 75 years could be cancelled under the provisions of an Act of parliament of 1975. Unused space in that grave could then be reclaimed for burial, or alternatively, if the grave is set within consecrated ground, the grave could be re-used subject to a Faculty. In these instances memorials would be selected and where appropriate restored and re-inscribed. The whole process would require the adherence to a Conservation Management Plan bespoke to each cemetery. Reclamation of graves along with the restoration/re-inscription of memorials has also been successfully implemented at the City of London.

Other measures proposed in the medium term include development of mausoleum sites in Camberwell Old and Camberwell New and the remediation and use of a disturbed area of ground (currently being investigated) in the north west of Camberwell Old.

A range of actions need to be taken to progress these options including that existing records need to be collated digitally and reviewed thoroughly. A protocol for assessing the heritage value of graves and memorial needs to be introduced along with a code for the treatment and recording of historic memorials. New record keeping and management procedures will also need to be introduced. Periodic reviews (nearing the end of the short and medium term periods) would be required to check whether supply of plots is meeting demand and to consider, at each critical stage, what next steps need to be taken. Medium term options potentially provide space until 2040 depending on burial rates and delivery of space.

Long term options proposed include the re-use and reclamation of both private and public graves. At Camberwell Old successive clearances of memorials in the late 20C, combined with the irregular and tight layout of plots and the numerous recent graves slotted in between historic graves, makes comprehensive re-use difficult. In addition the overgrown nature of parts of the site and the heritage value of other parts, makes comprehensive re-use inappropriate in parts. For these reasons

Camberwell New is proposed for *re-use* in the long term and that is proposed alongside continued but more limited reclamation and/or re-use in Camberwell Old.

There are however a number of critical issues to resolve in delivering this Strategy. Firstly, whilst other authorities in London may re-use private graves in areas that are not consecrated (under the provisions of Acts of parliament of 1976 and 2007) that same provision does not extend to Southwark on account of the way the 2007 Act is drafted. This needs legal clarification and/or a change in the law to remedy and it is proposed that Southwark should pursue that matter in the short and medium term.

Second, other than for some limited areas of public burial, most areas of Camberwell New do not become 'old' enough for re-use until at least 2045, by which time all the short and medium term options will have been exhausted. Some of the shortfall in capacity might be made up by taking up a portion of Honor Oak Park, (1/3rd) whilst retaining the football pitches and substantively enhancing the remainder of the Park. Recognising that this is likely to be unpopular and, at this point in time, not an option preferred by the Council the Strategy considers it essential that the authority should also conduct a review of Nunhead Cemetery to ascertain whether, mindful of the particular sensitivities and status of that cemetery, there is any scope for limited reclamation/re-use in conjunction with restoration. In addition, working in partnership with other London authorities, the council should seek to secure alternative burial space, (potentially also including natural burial space) by way of an additional landholding.

Having met the shortfall and subject to having resolved the legal issue and gained Faculty approval, Camberwell New might potentially be capable of carefully planned re-use in the long term.

Moving toward a system whereby sustainable, cyclical, re use of burial space is achieved on a long term basis is a goal. Achieving that goal will not only depend on future demographics and burial preferences but it will also require a new approach to the management of Southwark's cemeteries.



KEY

Short term
(2011-2022)

Medium term
(2022-2040)

New/refurbished carriageway
New/refurbished footpath

New/refurbished carriageway
New/refurbished carriageway
(subject to extinguishing rights)

New/refurbished footpath
New/refurbished footpath
(subject to extinguishing rights)

- H:** New Burial Layout-Public Areas
New Lawn burial layout on previously topped up and unused space. Approximately 480 plots.
- H1, H3:** Re-use of Public Graves
New Lawn burial layout on Public areas under Facility 1. Approximately 810 plots.
- J,K,L:** Re-use of Public Graves
New Lawn burial layout on Public areas under Facility 1. Approximately 1060 plots.
- L1, L2:** Mausolea
Purpose designed structure on sites of chapels assumed and accessed and table height.
- E:** New Layout
Scrub clearance and burial on new plot layout. (Already completed in October 2011).



NOTE 1, Faculty Approval Process:
Consult with Diocese and follow diocese procedures. Seek permission from relatives and obtain Faculty approval. Estimate remains for re-plantment to appropriate new graves.

NOTE 3, Record review:
Re-use and/or reclamation relies on a comprehensive review of burial records to check on plot size, last interment, and/or depth available to last interment combined with site checking/recording of identifiable plots.

Z Re-use/Re-claim/Soil Top Up Public Area
Re-use of Public graves under Facility 1 (where consecrated) in combination with re-excavation of existing soil profiles and top up (including removal of unsuitable spoil and additional import of soil) to give sufficient depth to enable new burial layouts. Maximum of 1000 plots, all subject to further feasibility study.

(R1-R3, T, Q1-Q5)
Private Lawn / Kerb Set Areas
Facility 1 grave space where available under Facility 1 (where consecrated) or under 1975 Act (where non consecrated), and/or buried 'No-Use' under Facility 1, where consecrated.
All subject to detailed record review and plot identification on a plot by plot basis.
Assume simple Heathcote in lawn arrangement (top left seats) with predominantly new memorials but in accordance with a heritage code. (From 2022)

F1, F2: Burial on Unconsecrated Public Areas - subject to soil top-up (assume double depth burial). Approximately 600 plots.

G1, G2: Re-use of Public Graves (the site under Facility 1). Approximately 405 plots.

NOTE 1. Faculty Approval Process:
 Consult with Diocese and follow notice procedures.
 Seek permission from relatives and obtain Faculty approval. Evidence remains for re-vestment in appropriate new grave.

NOTE 2. Memorial Heritage Code:
 Reclamation/re-use of Private Graves to significant historic areas. Individual plots re-carved (i.e. burial on top of existing remains) or re-used (existing remains filled and re-oriented to consecrated place adjacent to bury where consecrated land and subject to Faculty approval). Graves Memorials of cultural/historical/technical significance would not be offered for unreserved Memorials to reclamation/re-use plots wherever possible, would be retained, re-sited, 're-vested', restored and re-inscribed as appropriate in accordance with a 'Memorial Heritage Code'. Where memorial retention is not possible, new memorials would be aesthetically appropriate to complement the historic setting.

NOTE 3. Record review:
 Re-use and/or reclamation relies on a comprehensive review of burial records to check on period to back list re-vestment, and/or depth available to list new monument, consistent with the checking/recording of the individual plots.



KEY

Historic Monuments (U1 -12)
 Progressively restore areas of large / distinctive historic memorials (obelisks / vaults). Reclamation/re-use of grave space under faculty on a very limited basis in accordance with a strict heritage code. Aim to restore original monuments even where not re-used/reclaimed. (from 2045)

Historic Monuments - Wooded (V1-4)
 Progressively clear dense woodland scrub and restore areas of large / distinctive historic memorials (obelisks / vaults). Offer reclamation/re-use of grave space under faculty on a limited basis in accordance with a strict heritage code, restoring and re-inscribing original monuments. (from 2045)

Historic Core (S, X, X1, Y, Y1, W1-4)
 Reclaim grave space where available (under faculty where consecrated) under 1975 act where non consecrated) and/or limited Re-use under faculty where consecrated. Restore, re-vest and re-inscribe historic & distinctive kerb-set / headstones, on existing plot arrangement in accordance with a heritage code. (from 2045)

Private Lawn / Kerb-set Areas (R1-R3, T, Q1-5)
 Reclaim grave space where available (under faculty where consecrated) under 1975 act where non consecrated) and/or limited Re-use under faculty where consecrated. All subject to detailed record review and on a plot by plot basis. Assume simple headstone in lawn arrangement (no kerb sets) with predominantly new memorials according to heritage code. (ongoing from 2022)

Mausoleum (L1, L2)
 Purpose designed structure on sites of chapels assumed and accessed and pile height (from 2022)

New / refurbished Cartpathway
 New / refurbished Footpath

Short / Medium Term Strategy
 Burials previously carried out under short / mid term strategy proposals on new lawn burial layouts

Secondary Woodland (O1-6)
 Maintain as woodland, manage for wildlife and landscape, include some progressive thinning. Develop programme of sequential clearance of scrub, survey and recording of monuments.

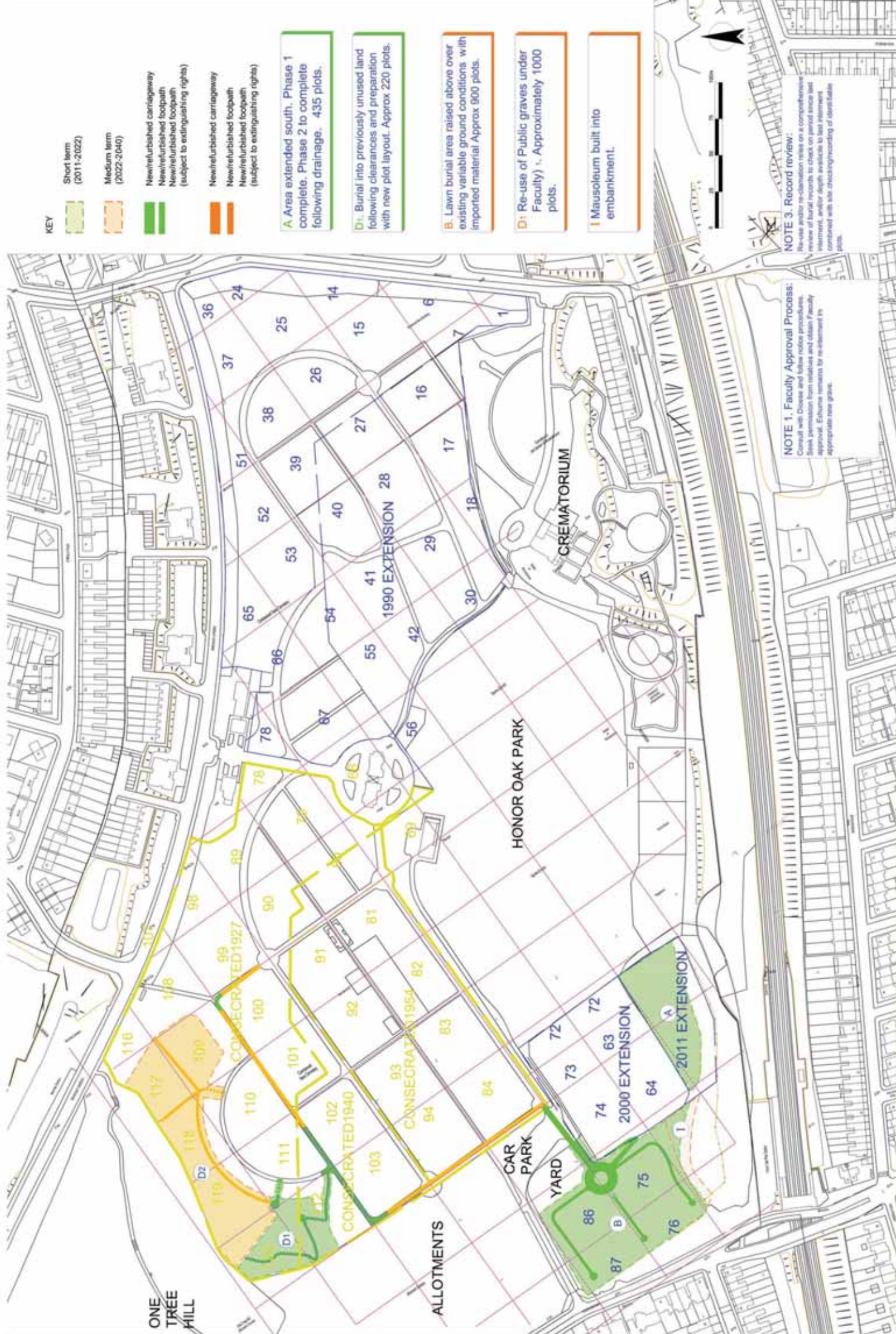

- KEY**
- Short term (2011-2022)
 - Medium term (2022-2040)
 - New/unrefurbished carriageway
 - New/unrefurbished footpath
 - New/unrefurbished footpath (subject to extinguishing rights)
 - New/unrefurbished carriageway
 - New/unrefurbished footpath
 - New/unrefurbished footpath (subject to extinguishing rights)

- A** Area extended south, Phase 1 complete, Phase 2 to complete following drainage. 435 plots.
- D1** Burial into previously unused land following clearances and preparation with new plot layout. Approx 220 plots.
- B** Lawn burial area raised above over existing variable ground conditions with imported material Approx 900 plots.
- D2** Re-use of Public graves under Faculty). Approximately 1000 plots.
- I** Mausoleum built into embankment.

NOTE 1. Faculty Approval Process:
 Consult with Diocese and follow minor procedures. Seek permission from relatives and obtain Faculty approval. Efforts remain for re-ablement in appropriate new grave.

NOTE 3. Record review:
 Re-use and/or re-clamation relies on a comprehensive review of burial records to check on period since last re-ablement, and/or depth available to last re-ablement combined with the checking/monitoring of adjacent plots.

ONE TREE HILL

ALLOTMENTS

HONOR OAK PARK

CAR PARK YARD

CREMATORIUM

2000 EXTENSION

2011 EXTENSION

CONSECRATED 1927

CONSECRATED 1954

CONSECRATED 1940

Private kerb set areas - Consecrated (B,D,E,G)
 Private kerb set areas to be laid out in accordance with Heritage Code (Subject to faculty and record review)

Public lawn areas - Consecrated (K,L,O)
 Public lawn areas to be laid out in accordance with Heritage Code (Subject to faculty and record review)

Private Lawn Burial areas - Consecrated (K,L,O)
 Private lawn burial areas to be laid out in accordance with Heritage Code (Subject to faculty and record review)

Historic Core Private Kerb-set (Gh)
 Private kerb set areas to be laid out in accordance with Heritage Code (Subject to faculty and record review)

Private Kerb Set Areas - Un-consecrated (C,J,M)
 Private kerb set areas to be laid out in accordance with Heritage Code (Subject to faculty and record review)

Private Lawn Areas - Un-consecrated (M,N,P)
 Private lawn areas to be laid out in accordance with Heritage Code (Subject to faculty and record review)

Public Burial Areas (Un-consecrated) (I)
 Public burial areas to be laid out in accordance with Heritage Code (Subject to faculty and record review)

Historic Private Kerb-set - Un-consecrated (Cc)
 Private kerb set areas to be laid out in accordance with Heritage Code (Subject to faculty and record review)

New Lawn Burial - Un-consecrated (Aa)
 New lawn burial areas to be laid out in accordance with Heritage Code (Subject to faculty and record review)

AREA REFERENCE and TARGET DATE FOR BURIALS

Aa	2040-2050	Ga	2065-2075	Ma	2085-2095
Ba	2045-2055	Ha	2065-2075	Na	2095 +
Ca	2045-2055	Ja	2075-2085	Pa	2095+
Da	2050-2055	Ka	2075-2085	La	2085-2095
Ea	2055-2065	La	2085-2095		

KEY

- Private kerb set areas - Consecrated (B,D,E,G)
- Public lawn areas - Consecrated (K,L,O)
- Private Lawn Burial areas - Consecrated (K,L,O)
- Historic Core Private Kerb-set (Gh)
- Private Kerb Set Areas - Un-consecrated (C,J,M)
- Private Lawn Areas - Un-consecrated (M,N,P)
- Public Burial Areas (Un-consecrated) (I)
- Historic Private Kerb-set - Un-consecrated (Cc)
- New Lawn Burial - Un-consecrated (Aa)

NEW / REFURBISHED CONTEMPORARY

NEW / REFURBISHED FUTURE

Short / Medium Term Strategy
 (Proposals to 2040)

Consecrated Boundary

Un-Consecrated Boundary

Section No.
85 85
 (Consecrated / Un-consecrated)

NOTE 1. Faculty Approval Process:
 Consult with Diocese and follow notice procedures.
 Seek permission from diocese and obtain Faculty approval. Evidence remains for re-instatement in appropriate new grave.

NOTE 2. Memorial Heritage Code:
 Reclaimability-use of Private Graves in Historic Core Areas: Individual plots re-claimed (i.e. burial on top of existing remains) or re-used (existing remains lifted and re-interred in a consecrated place adjacent (only where consecrated land and subject to faculty approval). Graves (Memorials) of cultural/historical significance would not be offered for reclamation. Memorials to be re-interred as appropriate in accordance with a Memorial Heritage Code. Where memorial retention is not possible, new memorials would be aesthetically appropriate to complement the historic setting.

NOTE 3. Record review:
 Re-use and/or re-claiming relies on a comprehensive review of burial records to check on period since last interment, and/or depth available to last interment contained with the checking/proceeding of identifiable plots.

Target dates and areas subject to each record review and periodic monitoring and review:

ONE TREE HILL

ALLOTMENTS

HONOR OAK PARK

CREMATORIUM

CAR PARK

WARD

2000 EXTENSION

2011 EXTENSION

2011 EXTENSION

2011 EXTENSION

2011 EXTENSION

2011 EXTENSION

